

Assemble manual of Geeetech acrylic Prusa I3

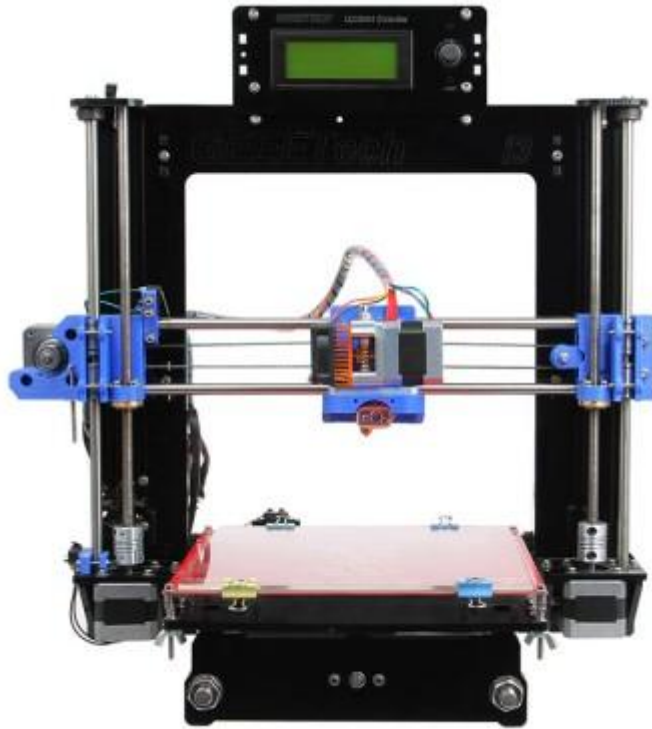

Prologue

As picture is much more helpful than words in assembly manual, so I use plenty of pictures and less word. If you have any questions, please contact me on www.geeetech.com and find me on Skype.

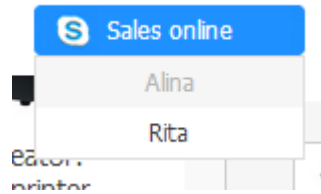

Unfold the package and take all the parts out to check the condition of the items.



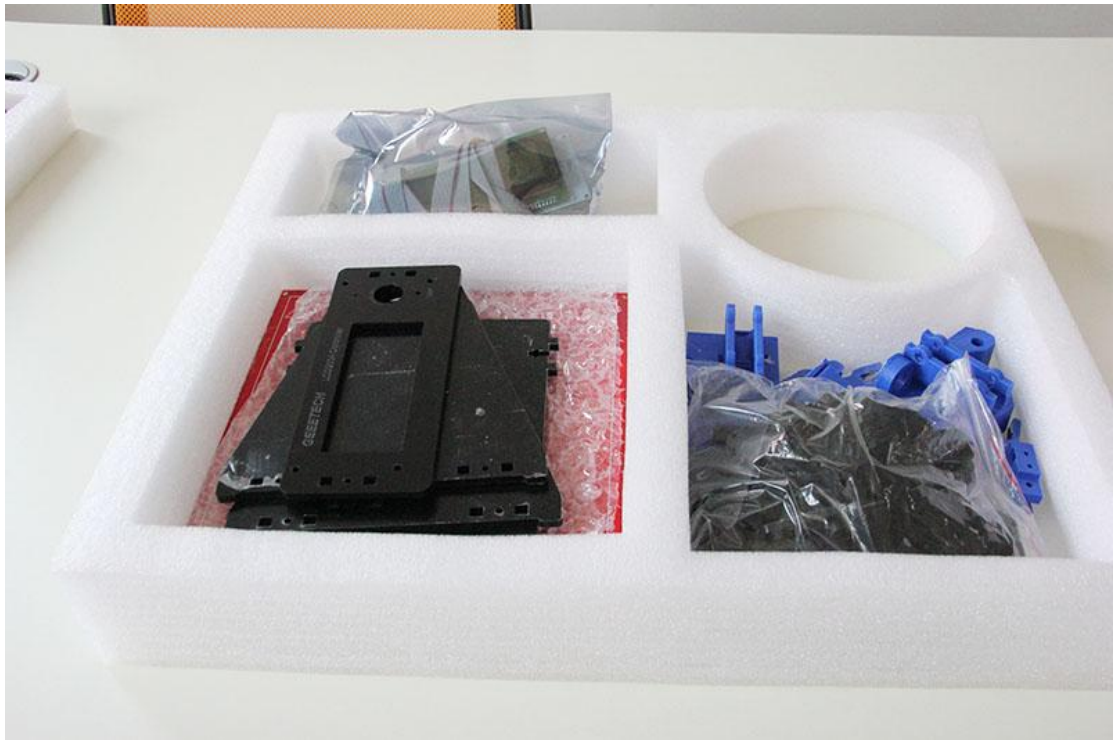



1. Assemble Y axis (the bottom part of the chassis)

1.1 Assemble the rods of a Y axis

Required parts	Part ID
M10 450mm threaded rod	NO.5
Acrylic Fender	NO.A 12
M8 spring washer	NO.17
M10 washer	NO.7
M10 nut	NO.12

Step1. Assemble the threaded rod

Thread the nuts and washers on the two M10 threaded rods separately. The order should be:
 M10 washer > M8 spring washer M10 screw > M10 screw > M10 washer > >A 12> M10 washer >
 M8 spring washer > M10 screw > M10 screw > M8 spring washer > M10 washer

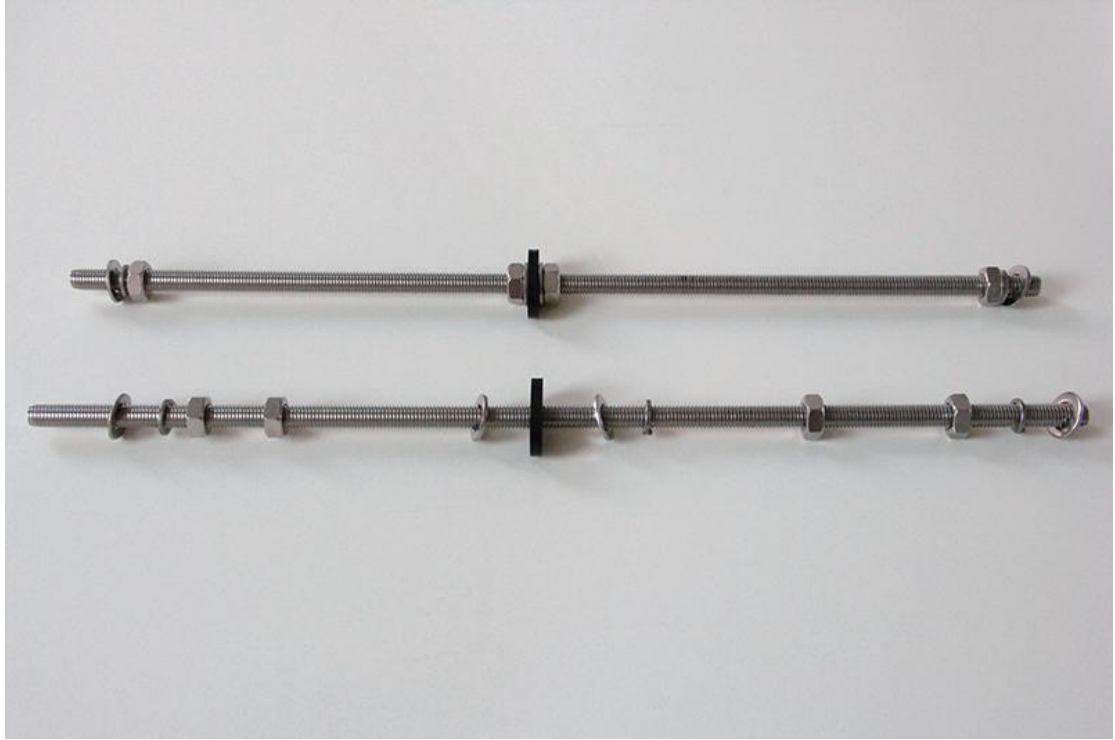

Step2. Assemble the Y axis smooth rod

Slide 2 bearings on each smooth rod. Before you slide the bearings please make sure they are clean. (Ignore the black one in between)

Required parts	Part ID
M8 410mm smooth rod	NO.3
LM8UU Linear Bearings	NO.32

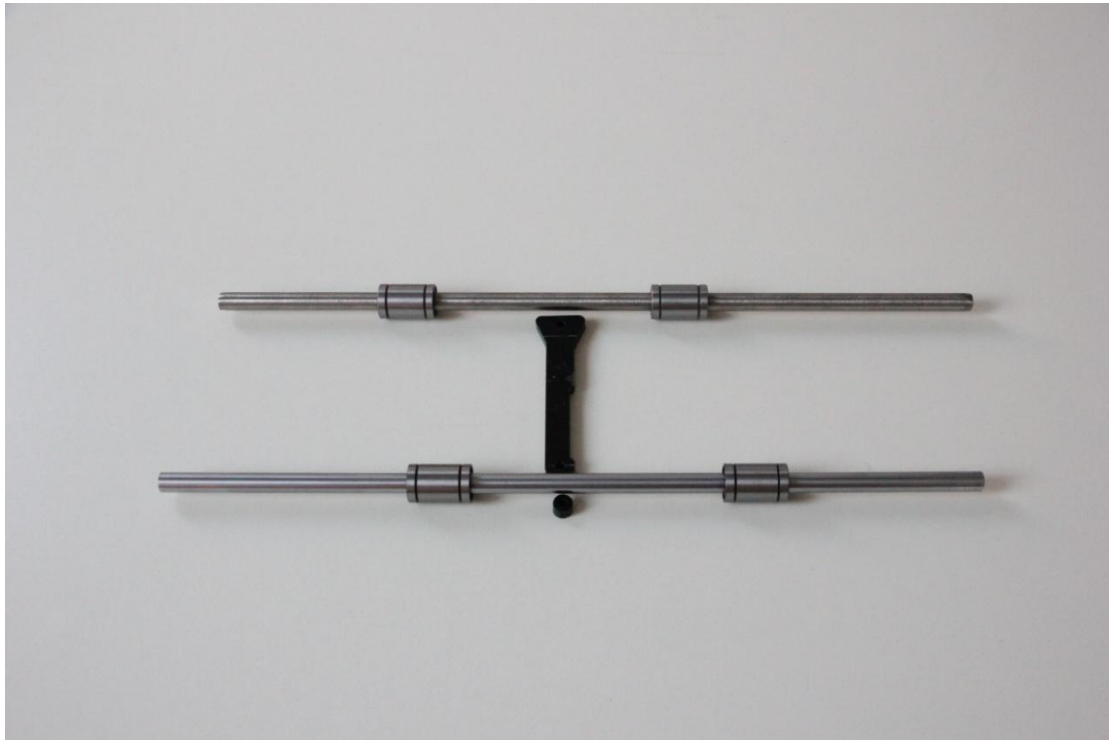

1.2. Attach the front and rear Acrylic support plates of the rods.

Required parts	Part ID
Acrylic plate	No. A7, A 8, A 9, A 10)
M 3 nut	N0.10
Acrylic Fender	No. A11

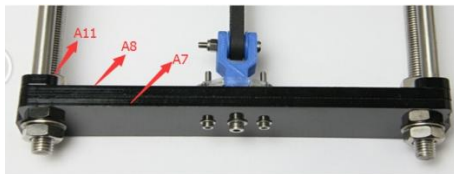

Front

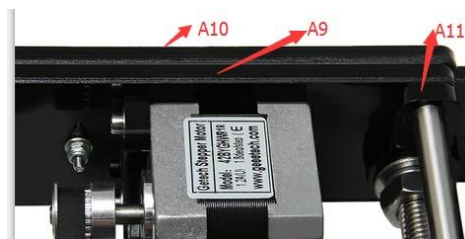

Rear



1.3 Assemble the Y idler

Required parts	Part ID
624ZZ Ball bearing	NO.31
Printed Y idler	NO. P8
M4 X25 screw	NO.28
M4 nut	NO.11
Y bearing limit block	A18
Retaining ring	P9

Step1. Put the screw through the printed Y idler piece, with the 624ZZ bearings in between. Lock the other end of a M3 nut.



Step2. Mount the assembled idler onto the front support plates.

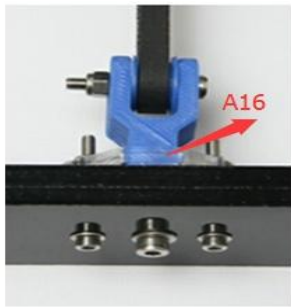
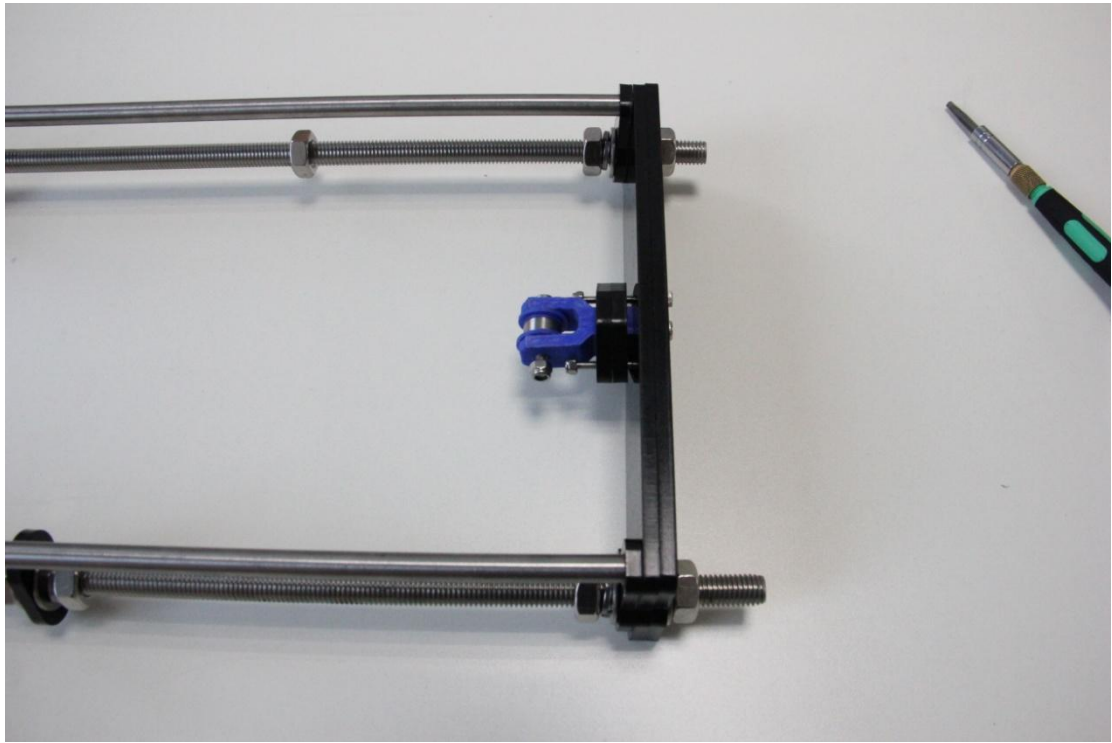

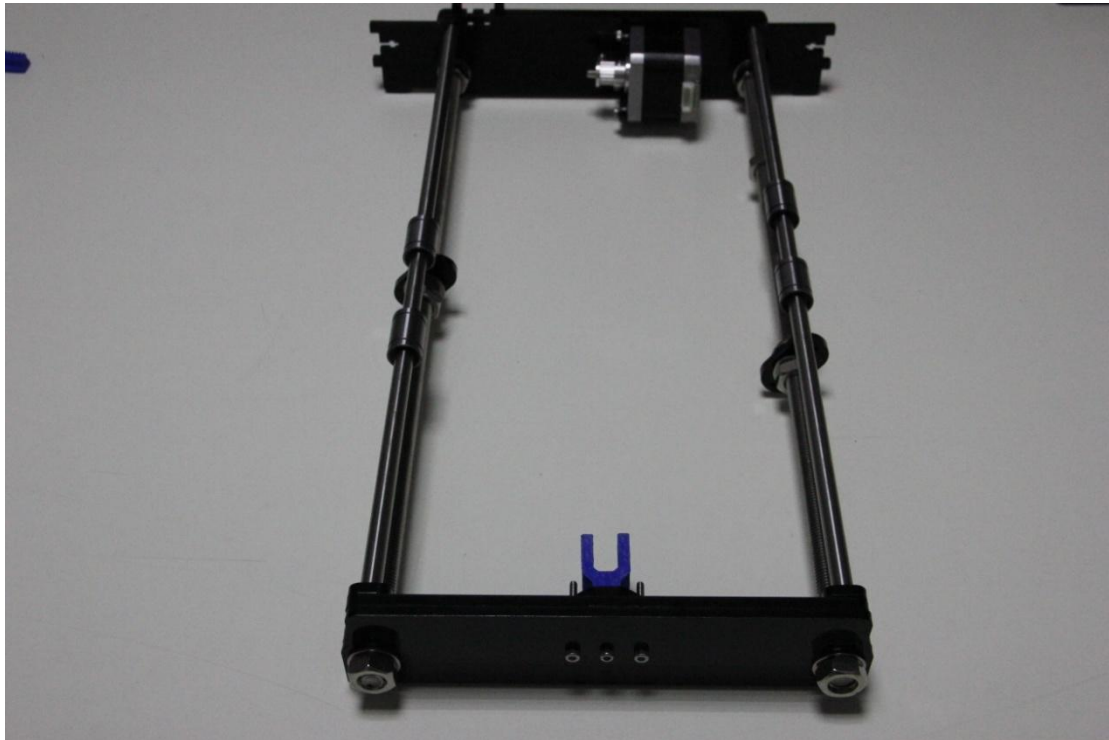

1.4 Mount the Y motor.

Required parts	Part ID
Y-axis motor block	NO. A13, A14
Stepper motor	60
pulley	35
M3 screw	20,24
M3 nut	10

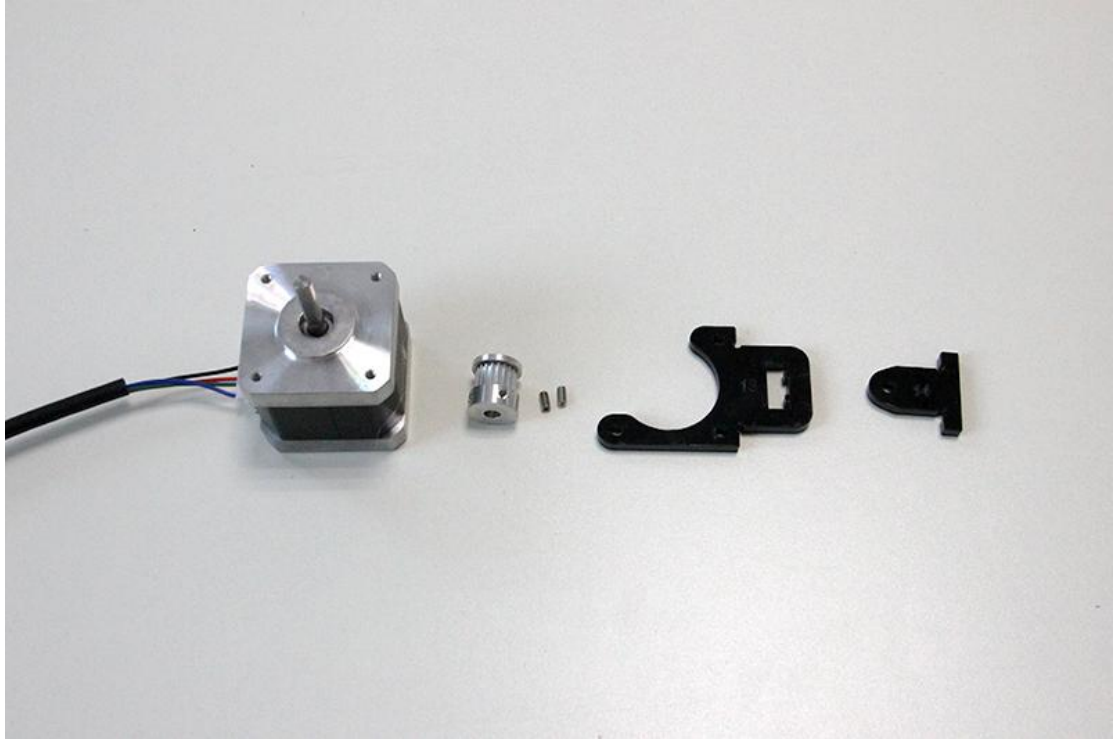

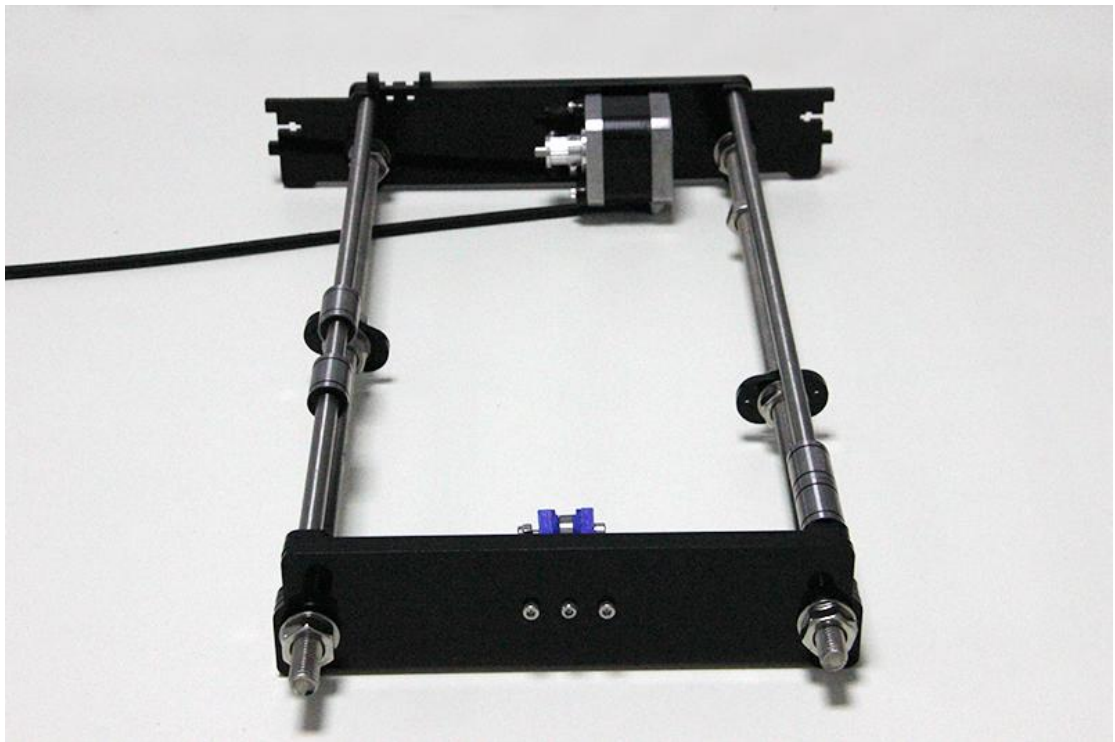
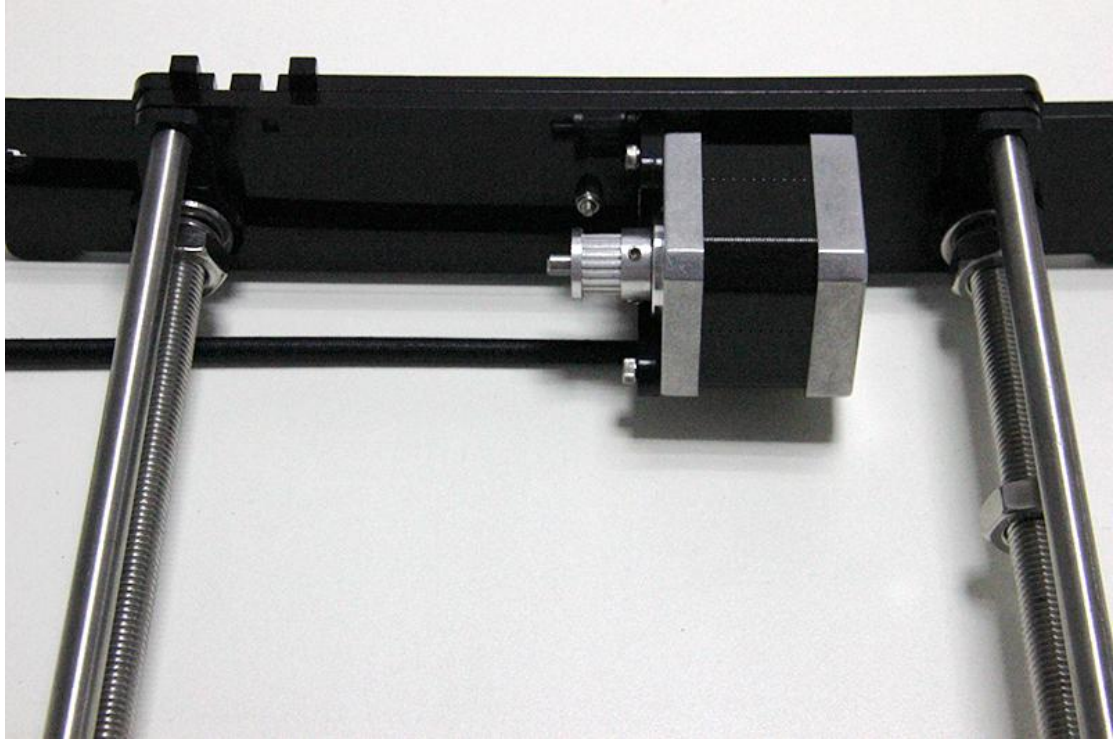

1.5 build the printing platform

Required parts	Part ID
Acrylic plate	No.A17
Acrylic fender (No.A17)	No.A17
Printed belt mount	No.P4,P5
Belt	34
Zip tie	45
M3 screw	24
M3 nut	13

Step1. Mount the belt mount on the bottom side of the plate.

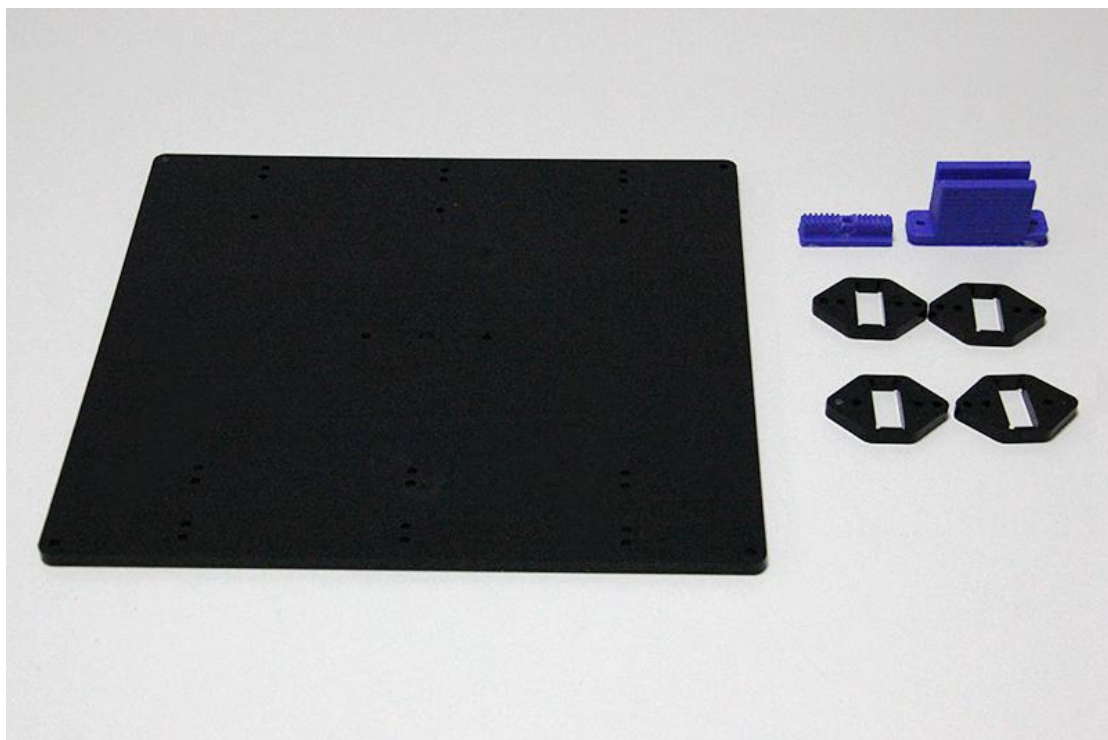

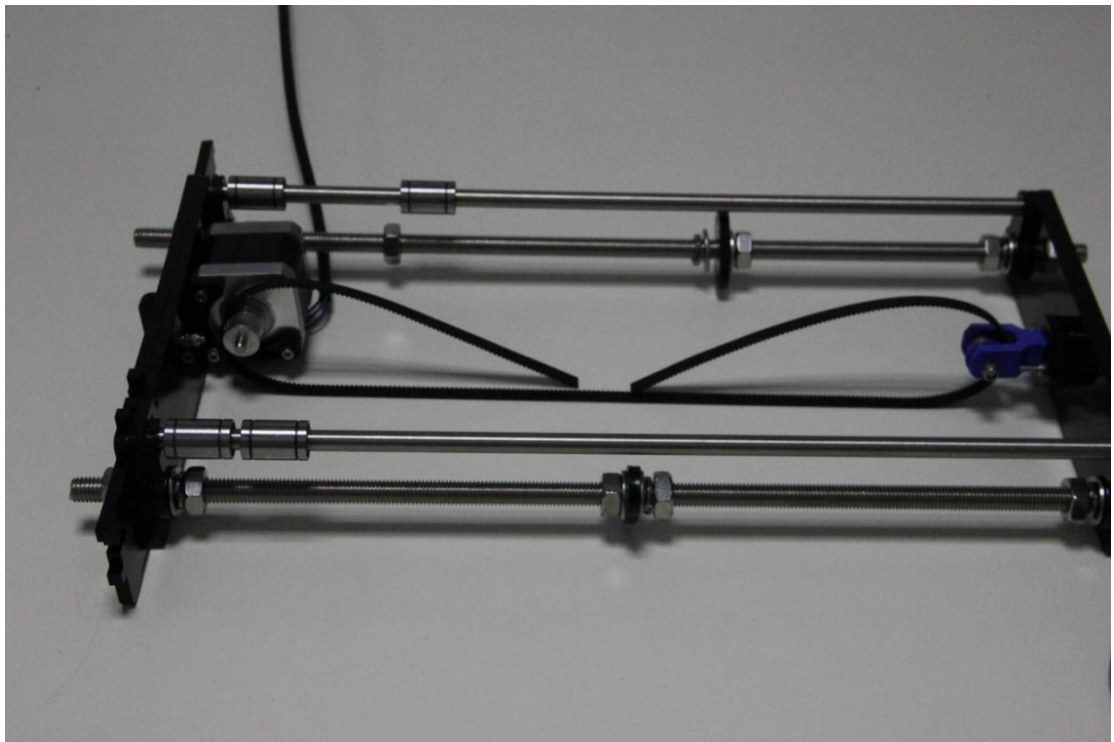
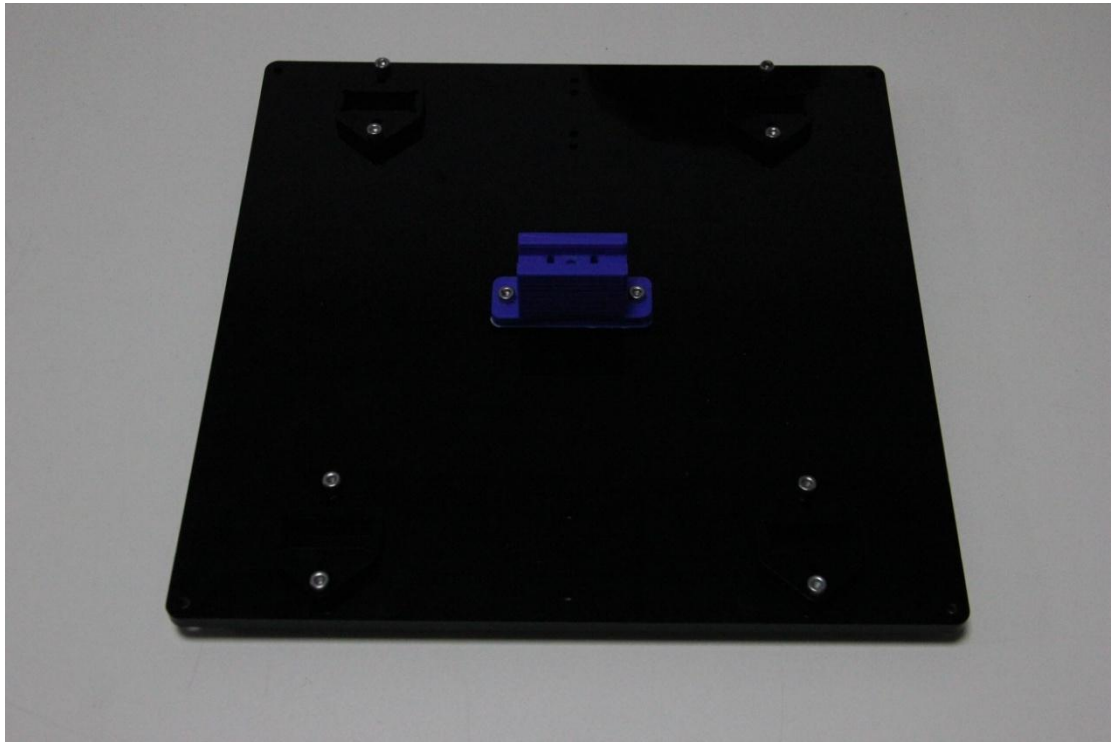

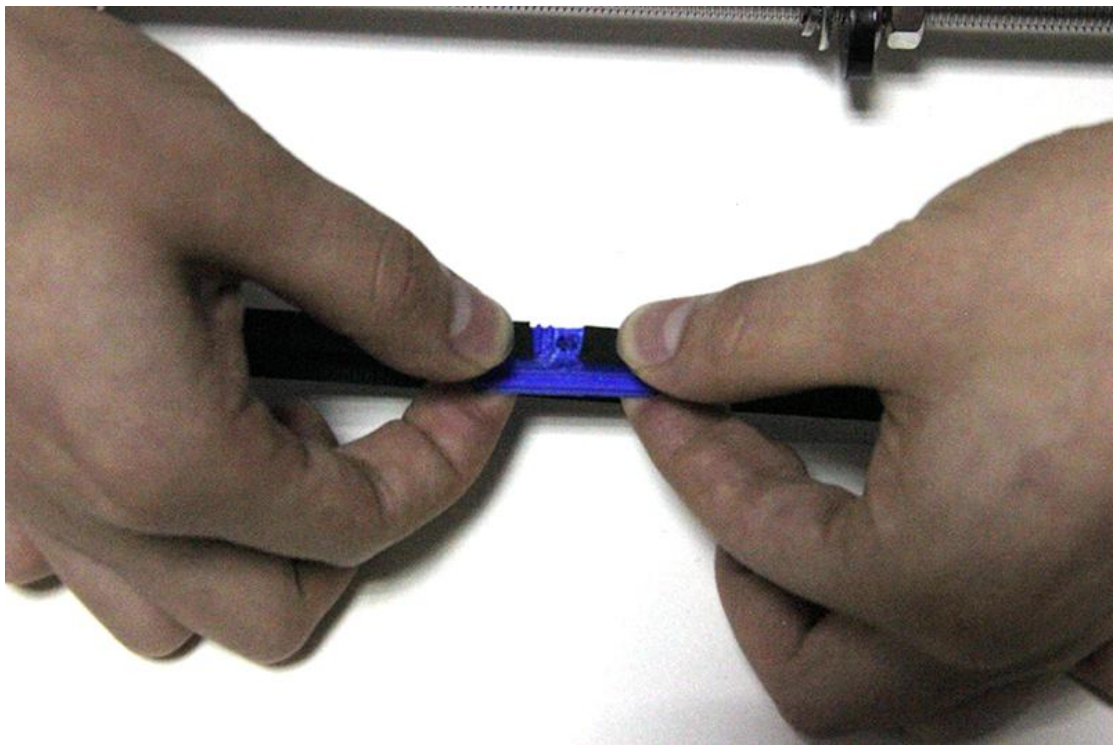
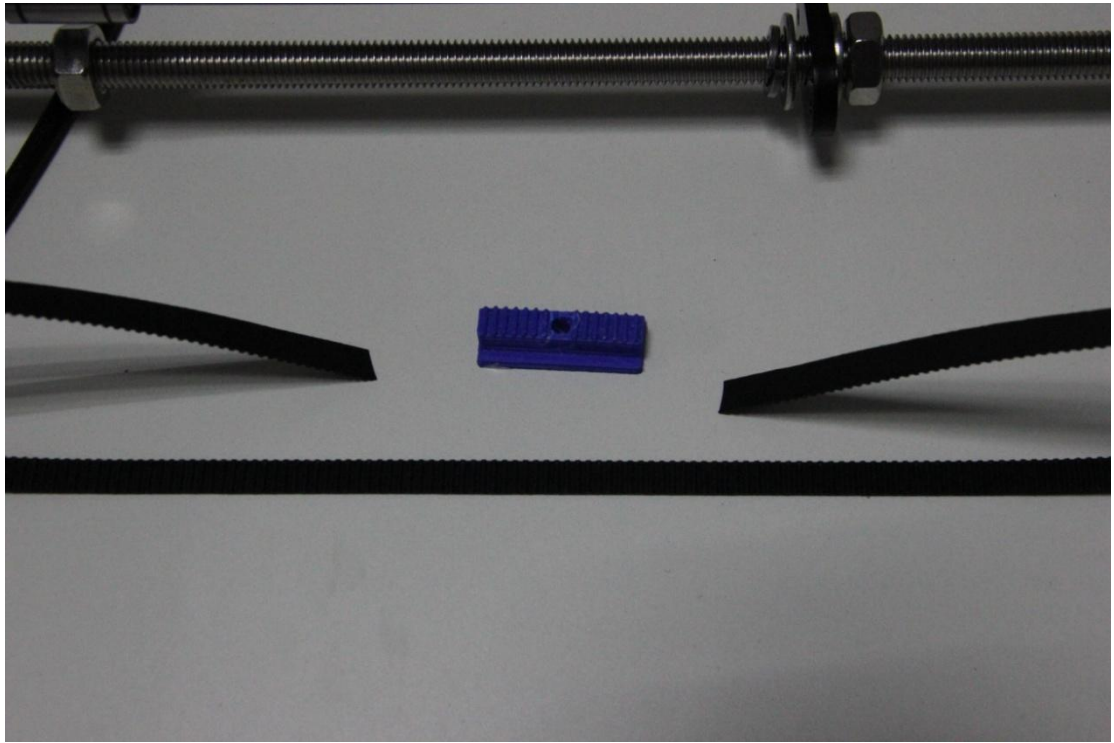

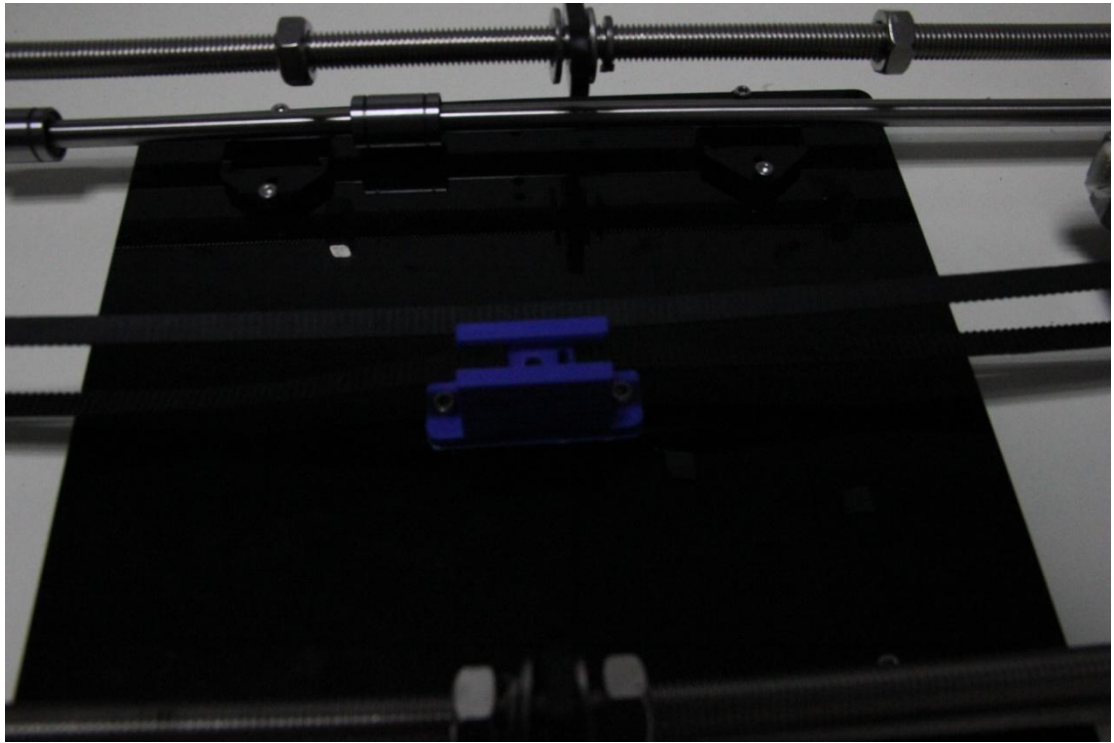

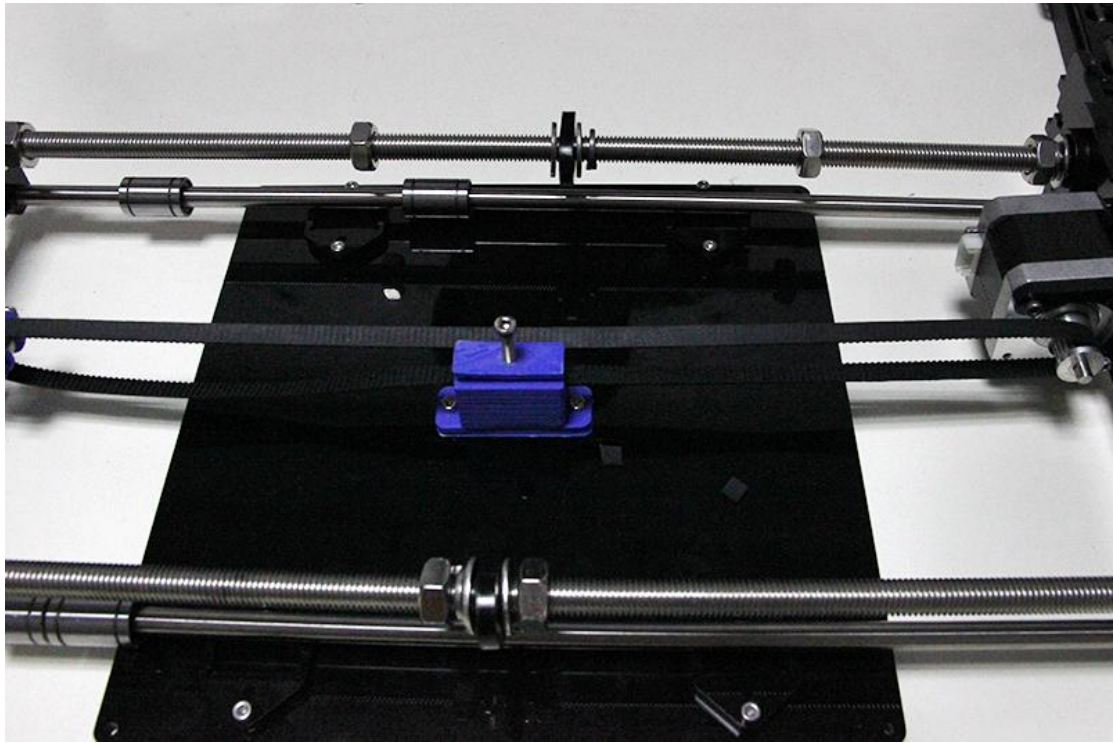

Step2. Get the build platform plate zip-tied to the 4 linear bearings.

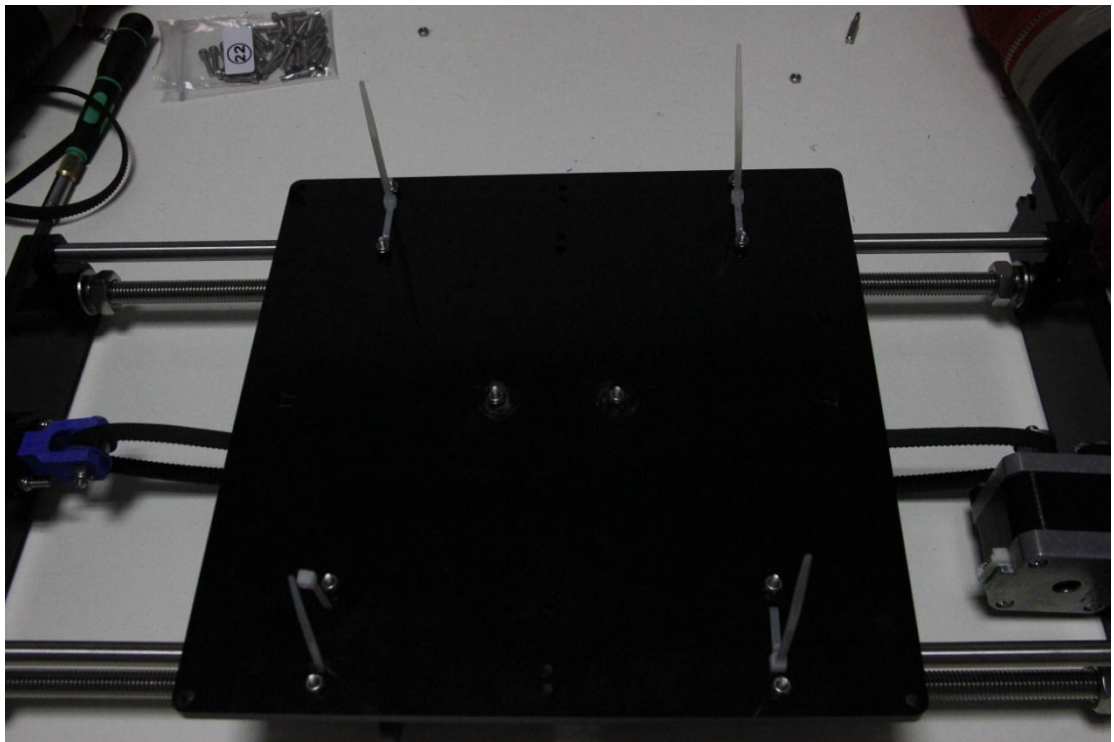

Step4. Attach he heated bed.

Required parts	Part ID
Heat bed	56
Heating wire	42
thermistor	Attached on the bed
Thermometry wire	41
Wing nut	15
Spring	30
M3 screw	24

The circled part need soldering.

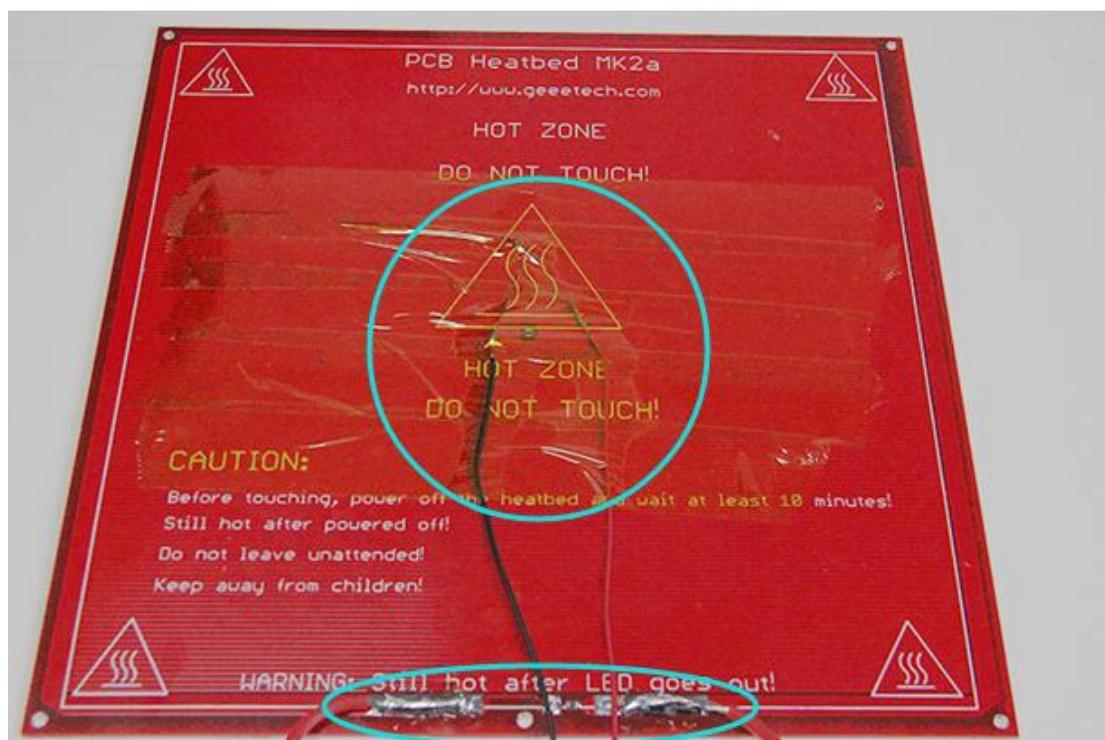

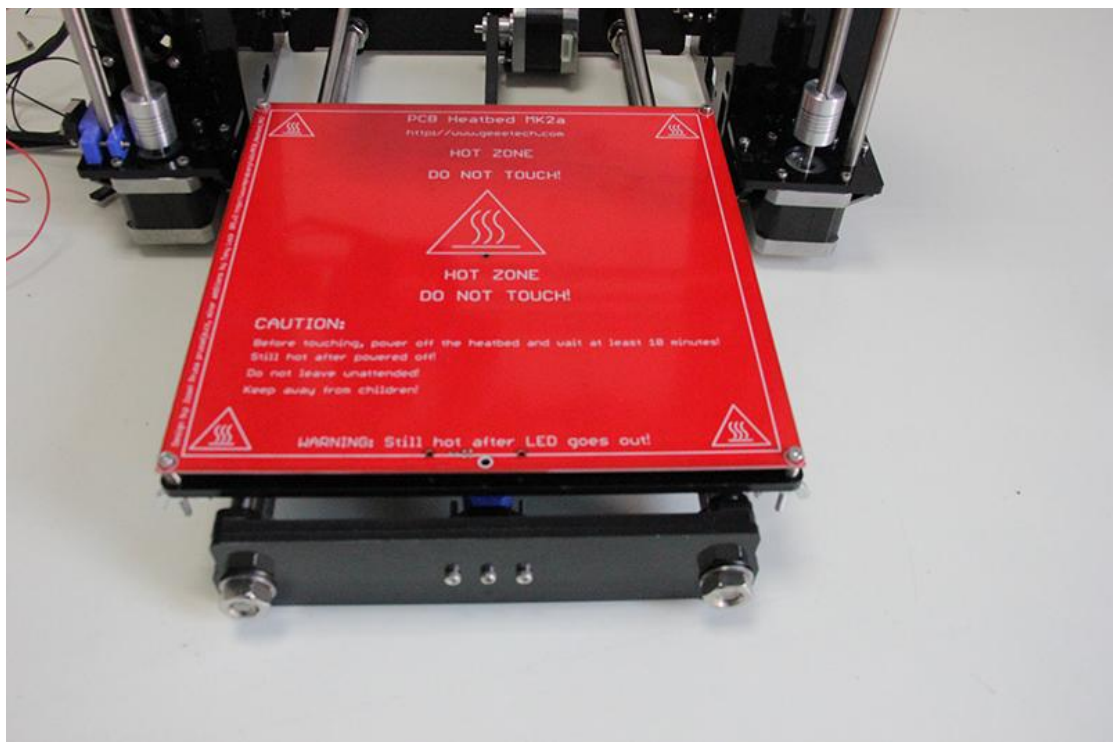

2. Assemble Y - Z axis

The main frame is held upright after the acrylic fender washers on the Y axis threaded rods. The front of the plate should be sticking out a lot further than the back.

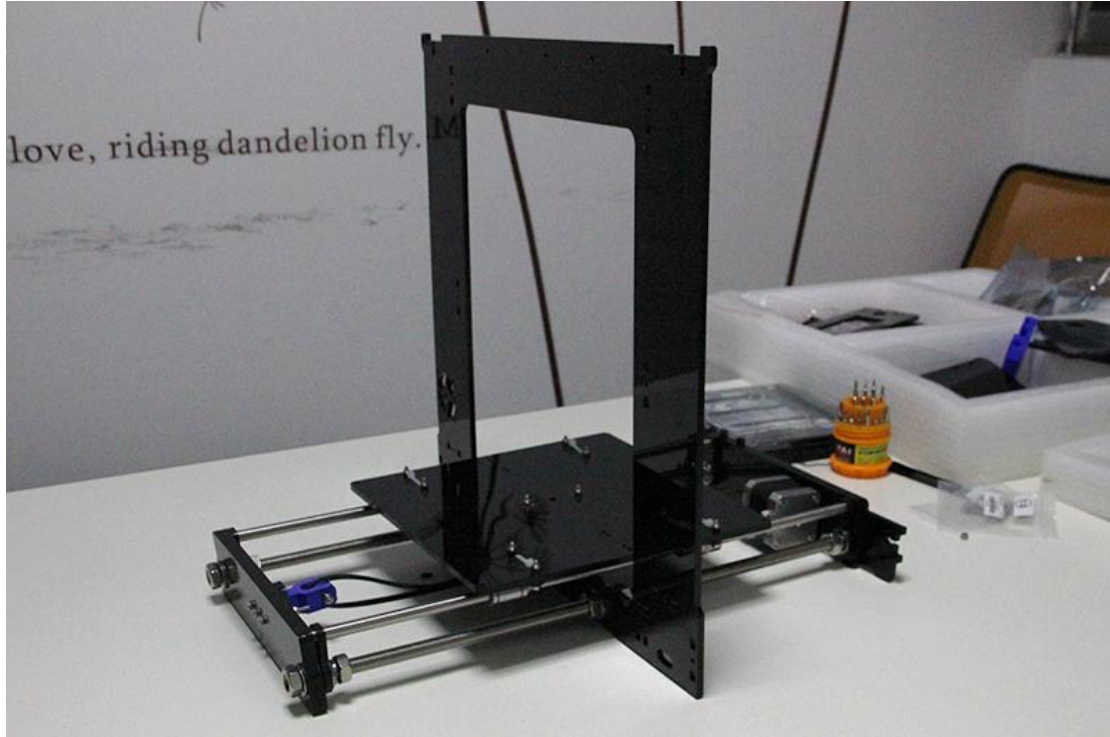

3. Assemble the right and left side panel

Required parts	Part ID
Acrylic left panel	(No.A2)
Acrylic right panel	(No.A3)
Acrylic rear block	((No.15)
Zip tie	45
M3 screw	22
M3 nut	10

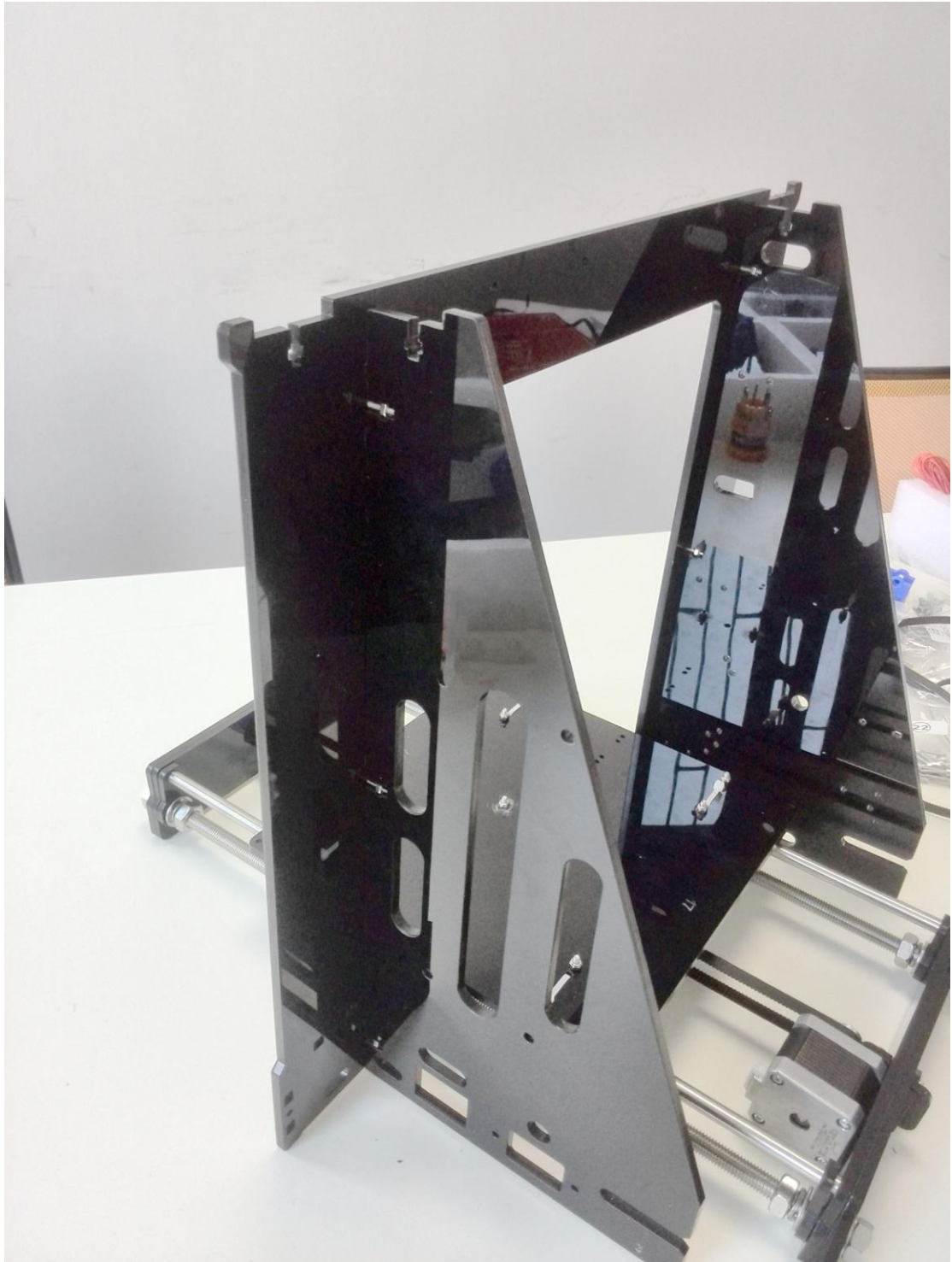

Mount the rear part of the Y axis and the side panel together.

Required parts	Part ID
Acrylic left panel	No.A15
M3 screw	22,23
M3 nut	10





4 Assemble the Z axis (the vertical axis)

Step1. Assemble the Z-axis bottom mounts

Required parts	Part ID
Acrylic left panel	(No.A4)
Acrylic right panel	(No.A5)
Stepper motor	60
M3crew	22,20
M3 nut	10

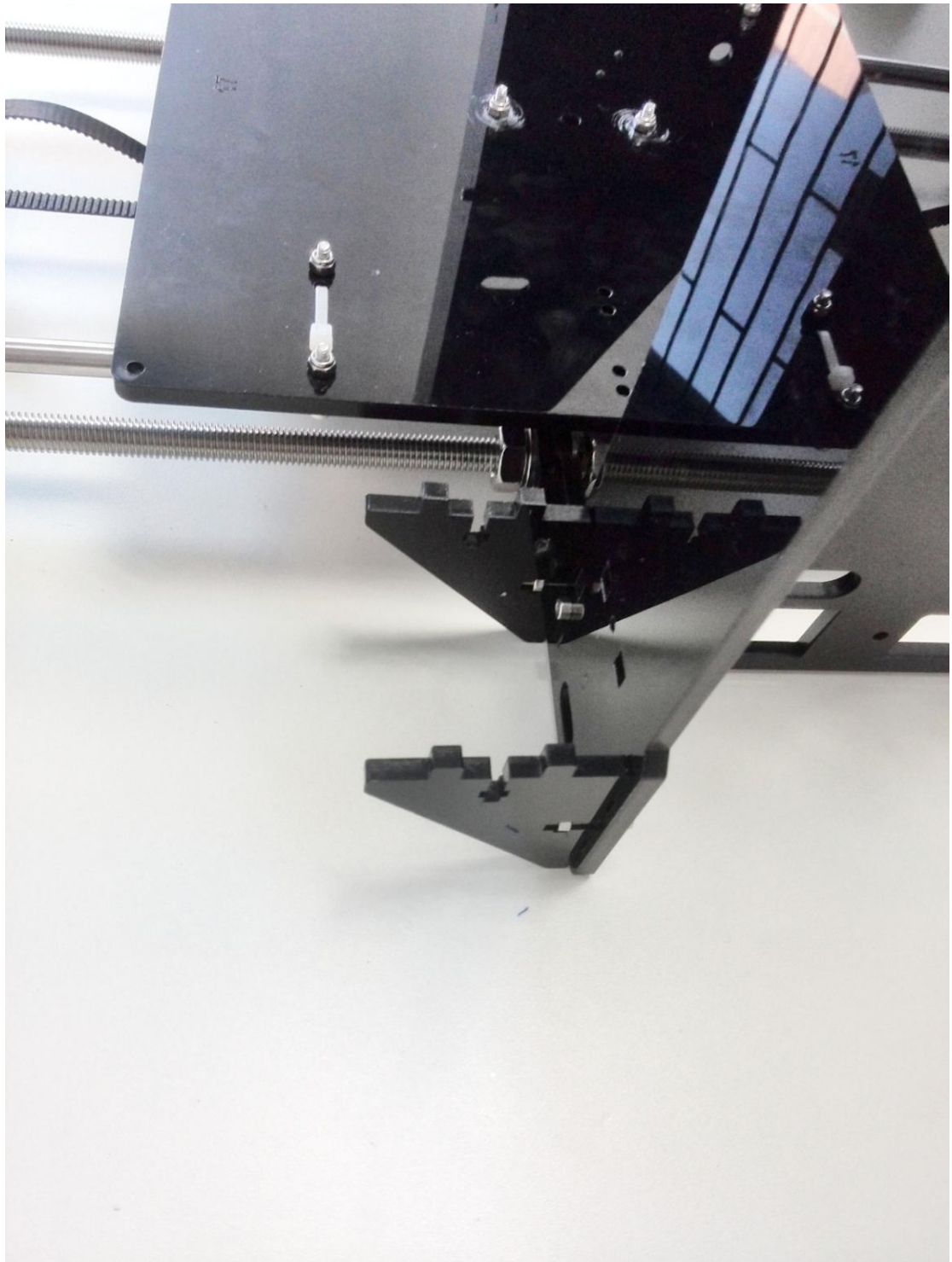

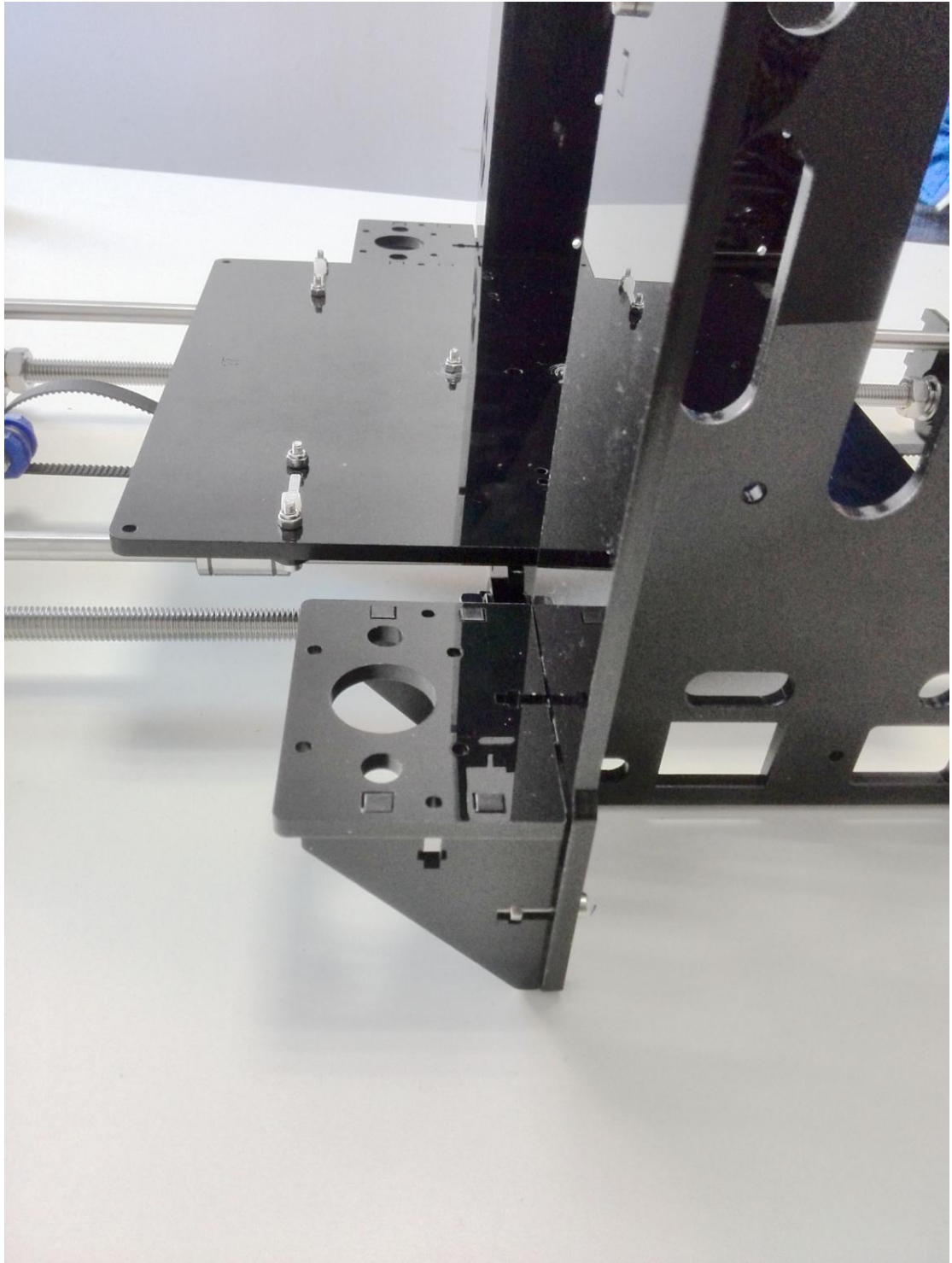

Assemble the 2 Z motors

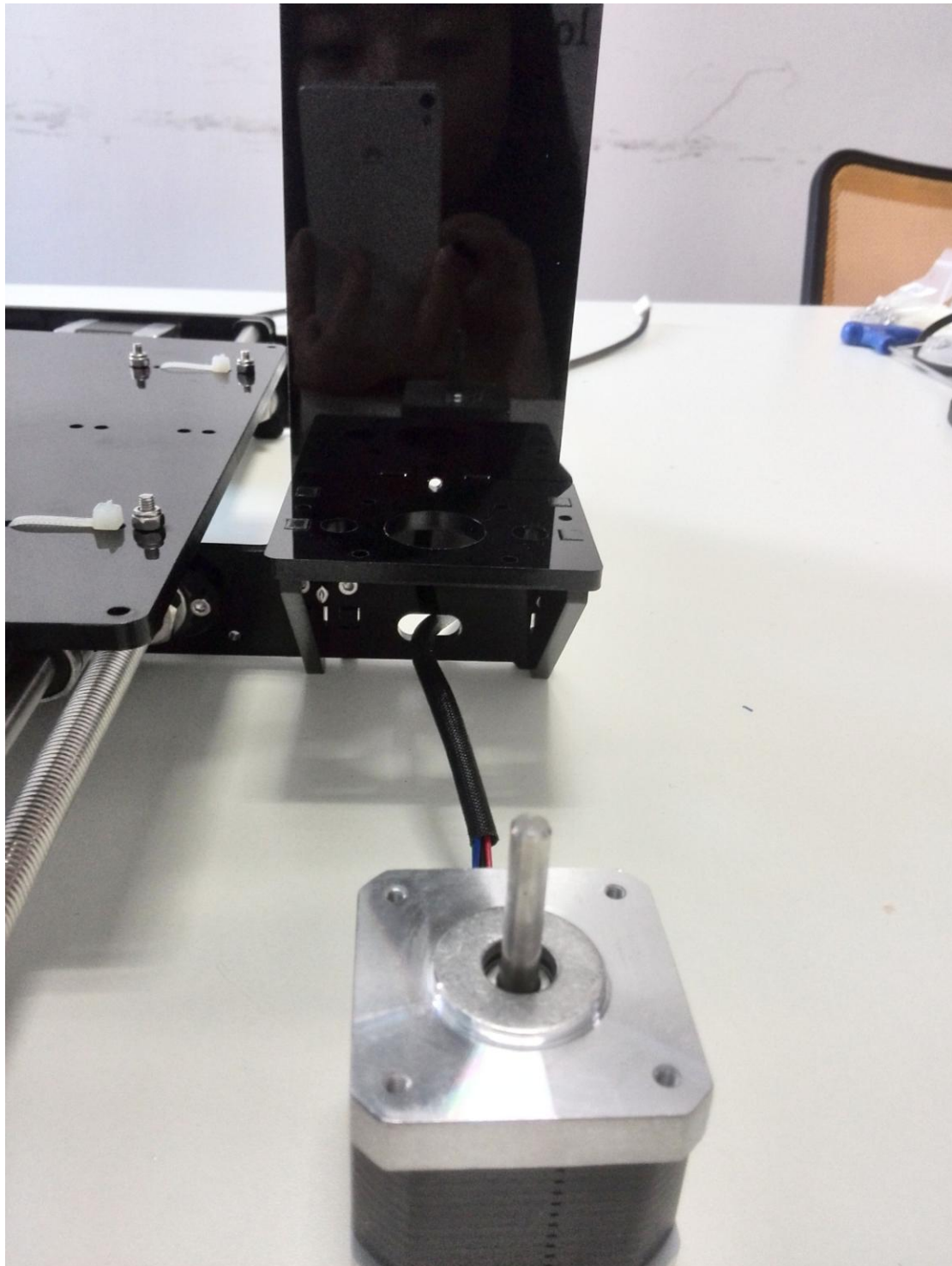

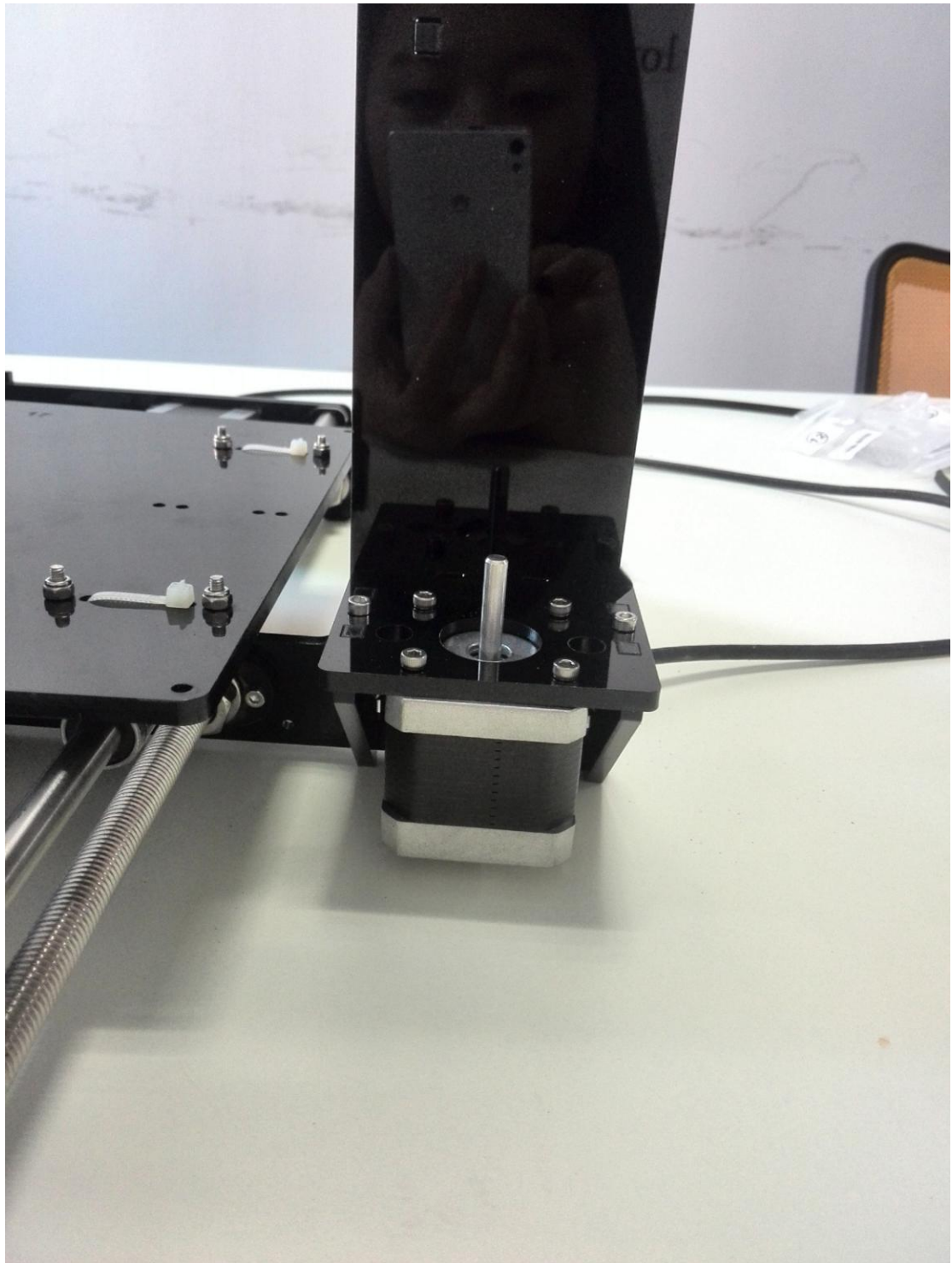

Mount the fan on the left side

Required parts	Part ID
Fan	55
M3 crew	24
M3 nut	10

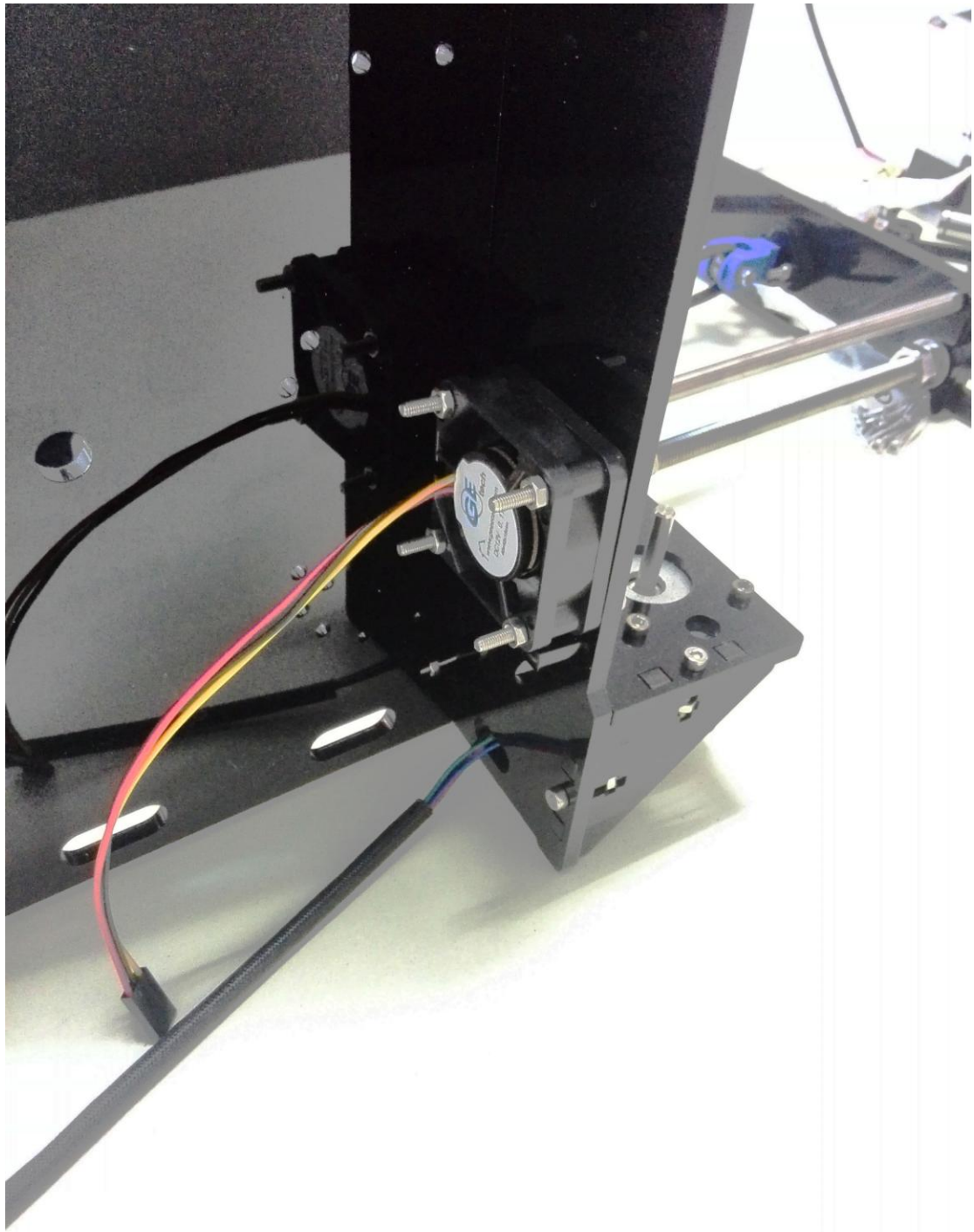

5 Assemble the X axis (the horizontal axis)

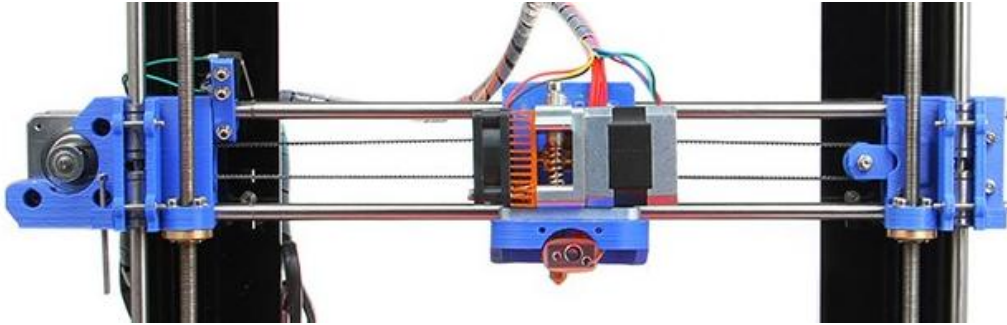

Step1. Assemble the X-Axis Idler

Put the screw through the printed Y idler piece, with the 624ZZ bearings in between. Lock the other end of a M3 nut.

Required parts	Part ID
624ZZ Ball bearing	NO.31
Printed Y idler	NO. P8
M4 X25 screw	NO.28
M4 nut	NO.11
Retaining ring	P9
X-axis optical axis bracket	P2



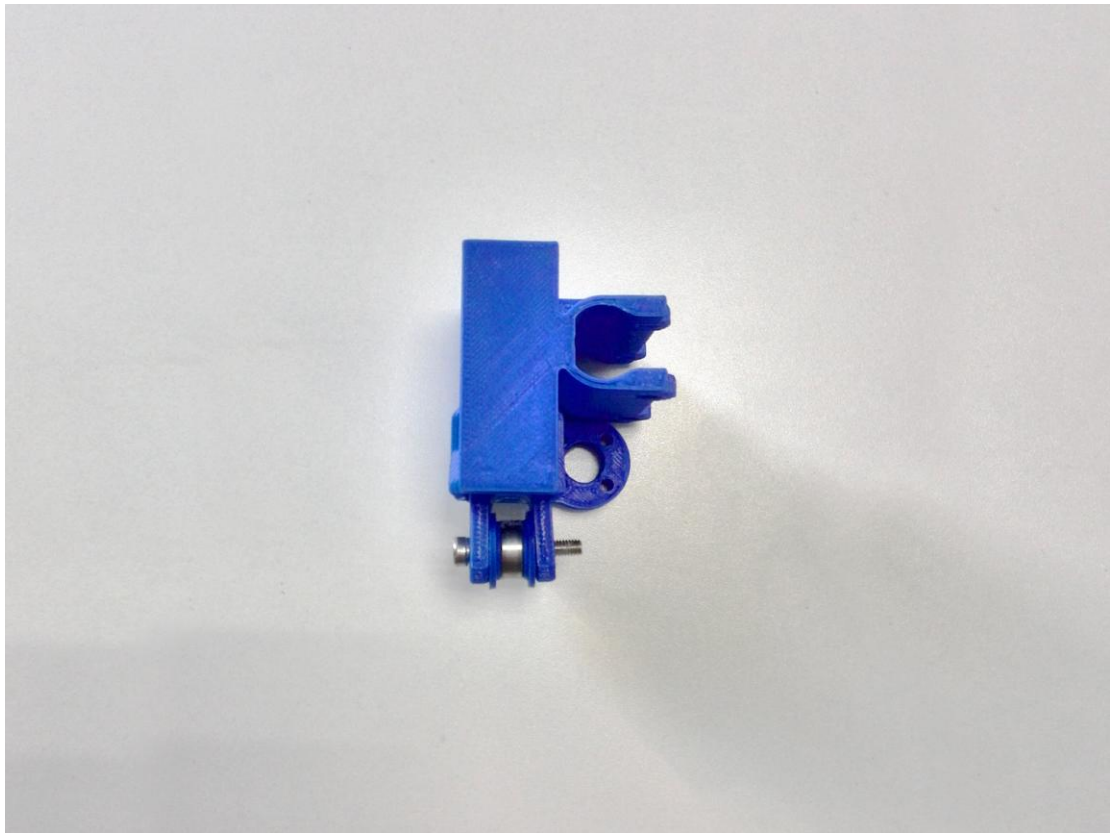
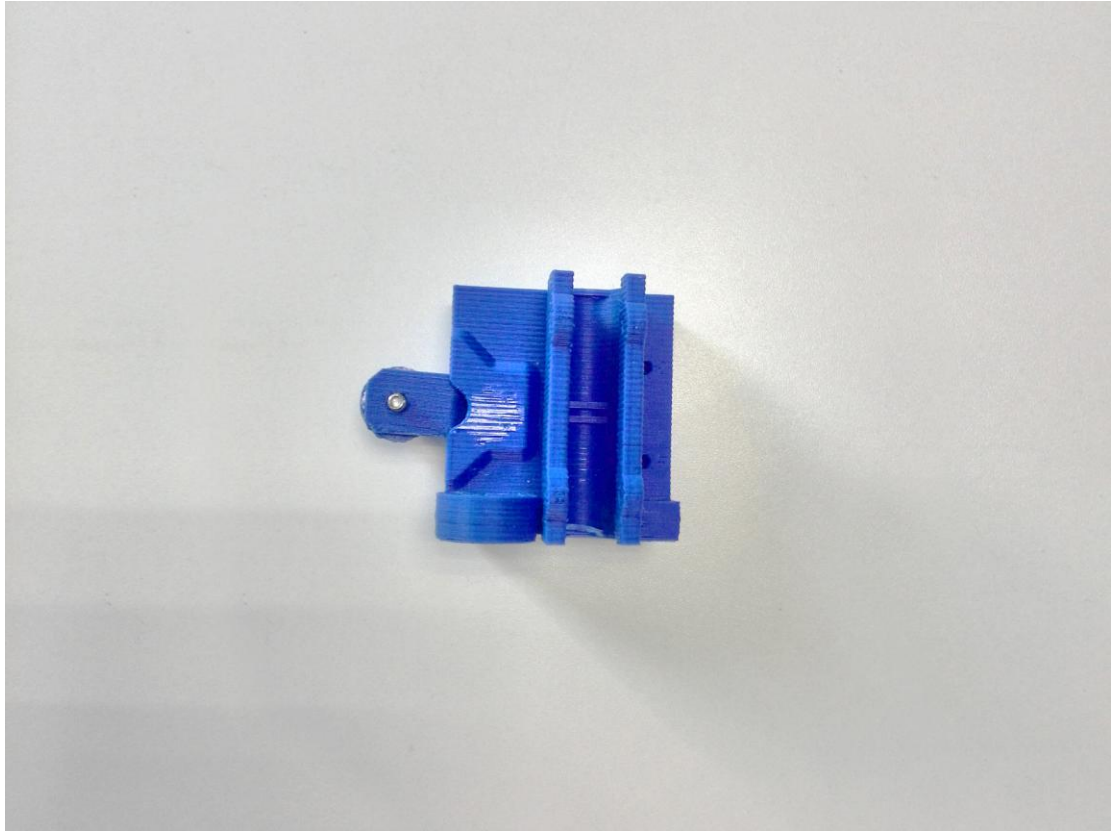

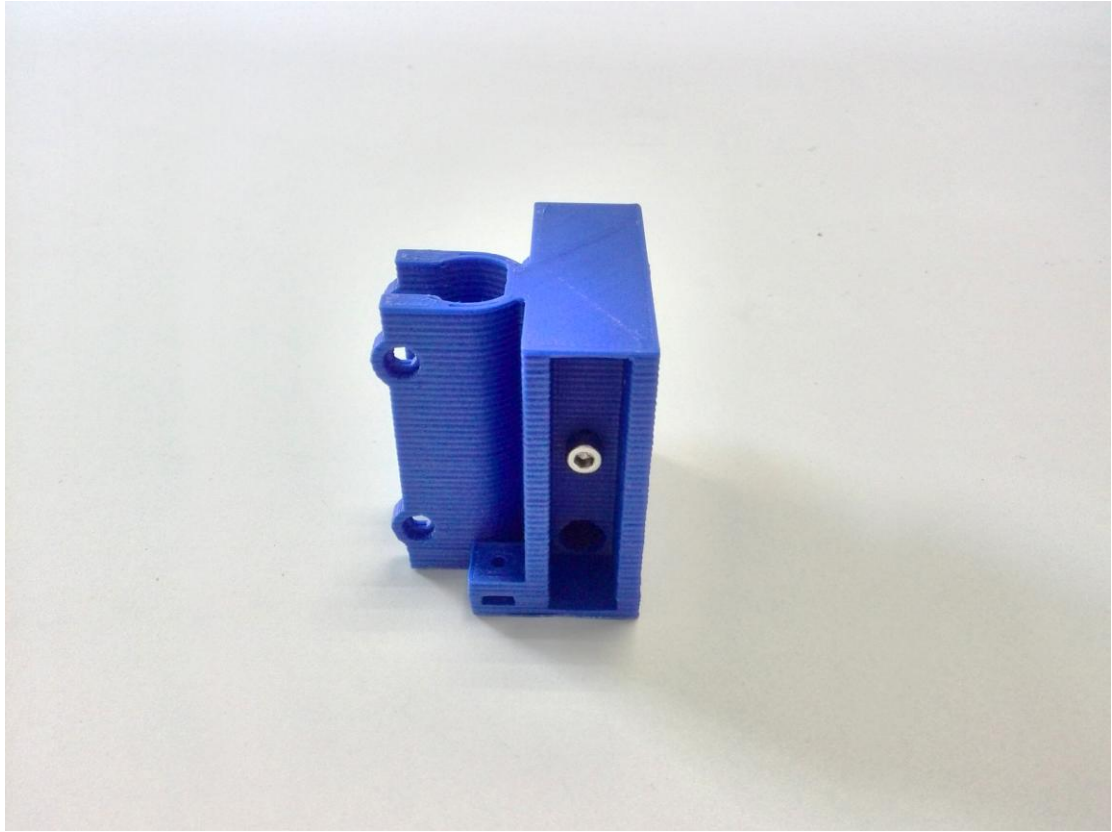

Step2.
Mount the idler into the following part

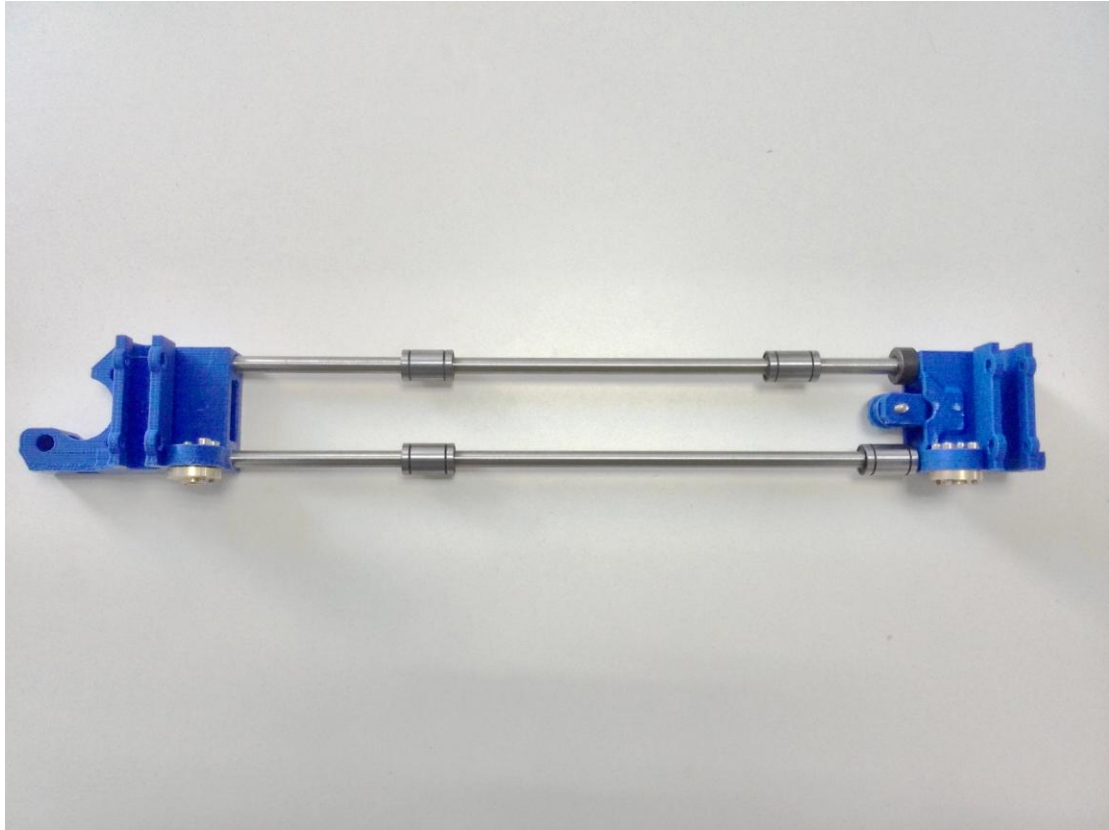

Step3. Assemble the 2 smooth rods. (380 mm)
Slide 2 bearings on the each rod as shown in the picture.

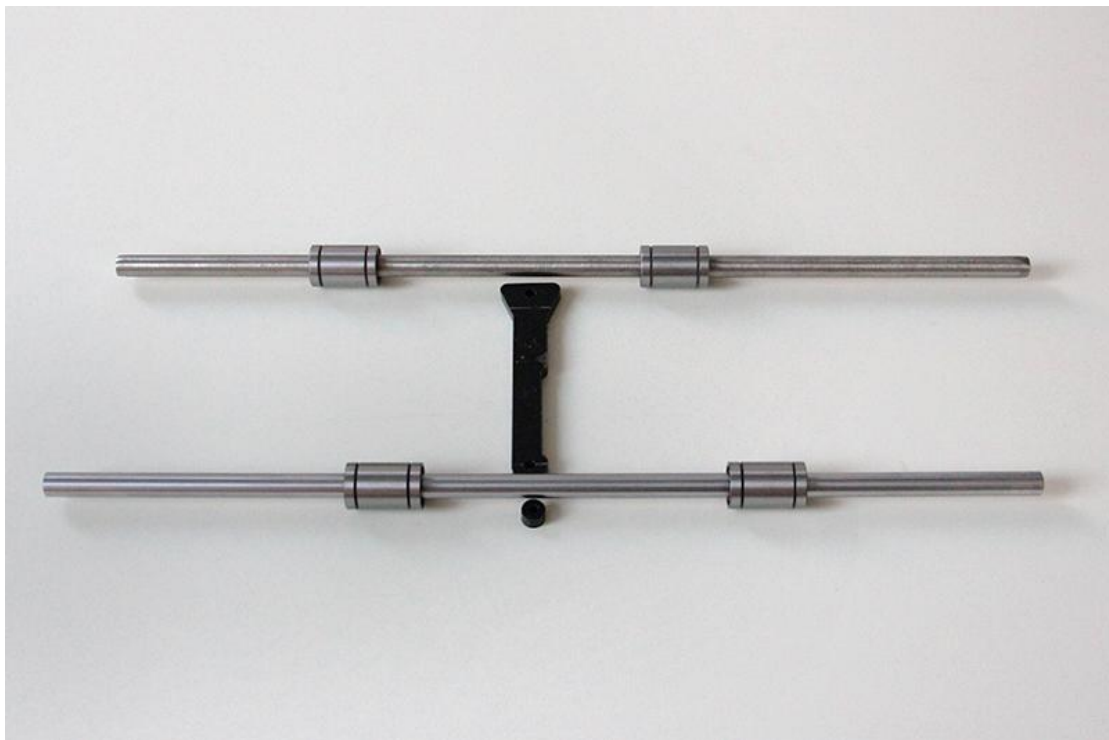

Slide the X-axis motor-end and the idler-end onto both ends of the smooth rods. The X-axis motor-end is on the left and the idler-end on the right. This is going to take some force, or you can use file to make the holes larger.

Mount the brass nut on the following part.

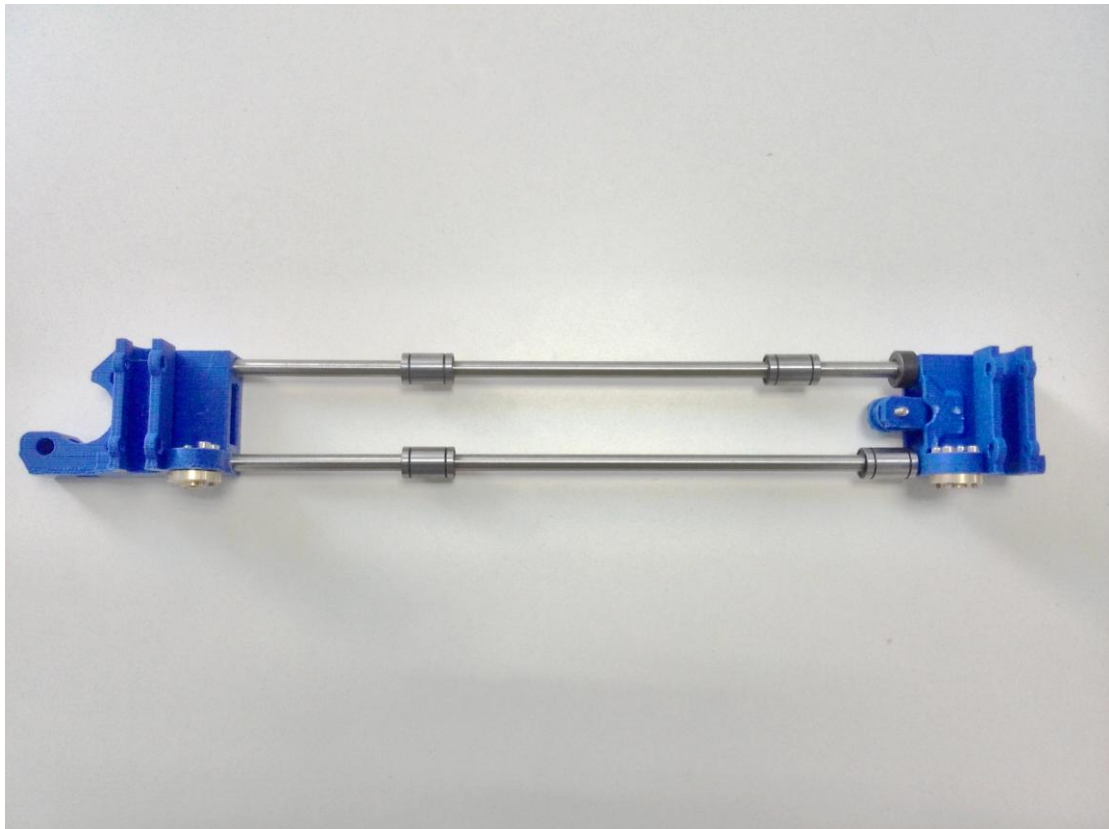

Insert the rest bearings into the bracket of both end of the smooth rod.

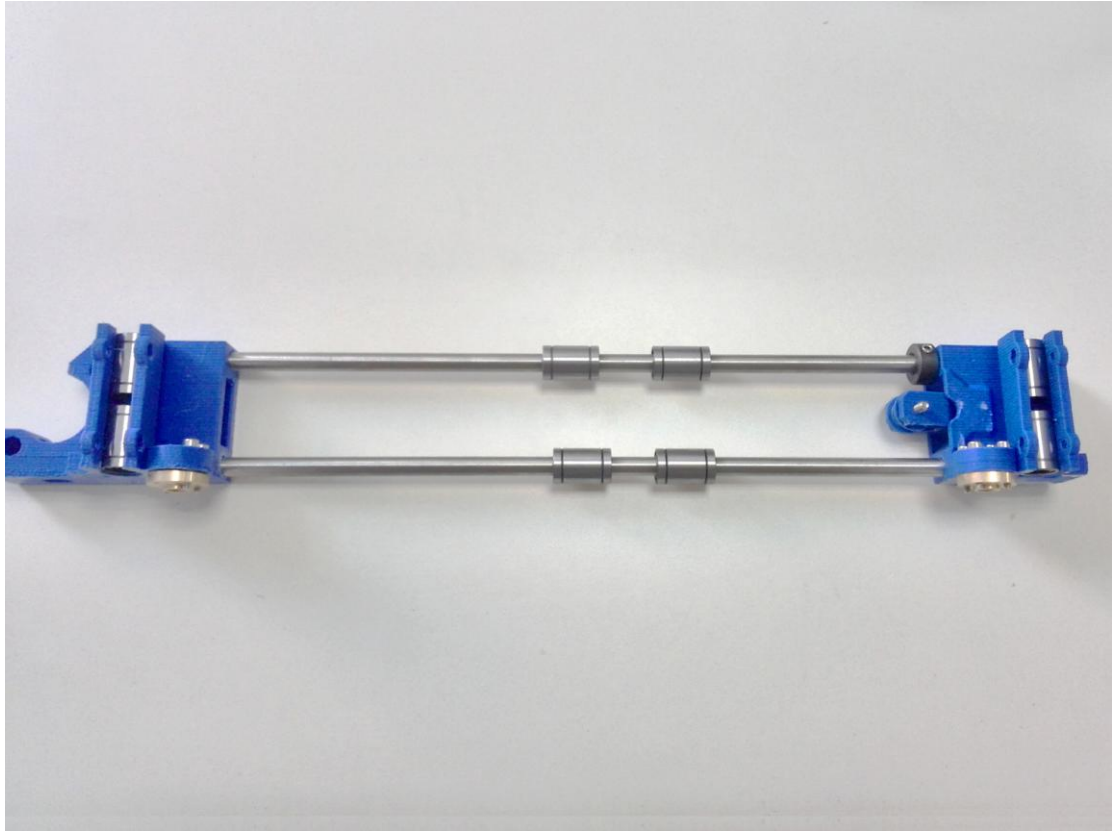

Thread the threaded rod through the following part. It would be easier to do it now.

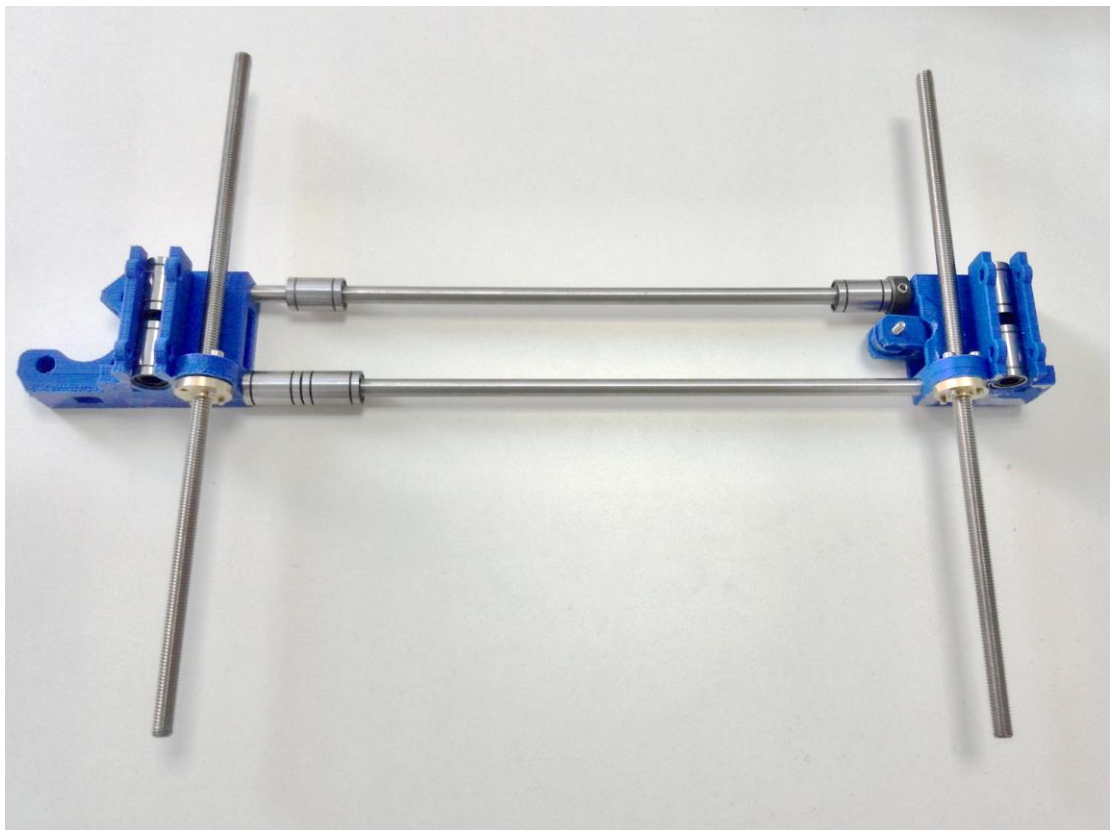

Fix the two pulleys on both if the threaded rod. And plug it on the motor shaft.



Assemble the X-Z axis.

Required parts	Part ID
Z-axis top mount	A6

Step1. thread the X-axis through the Z axis.

Step2 assemble the top mount of the Z-axis.

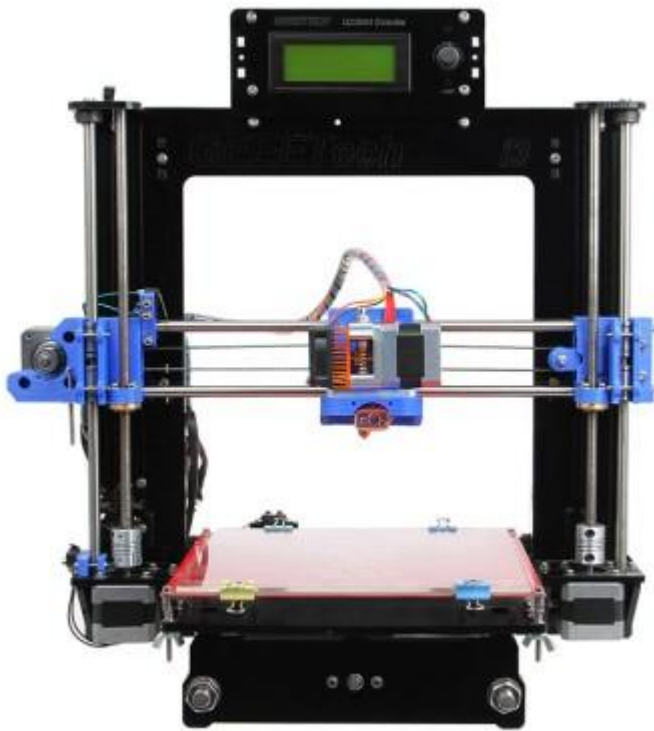
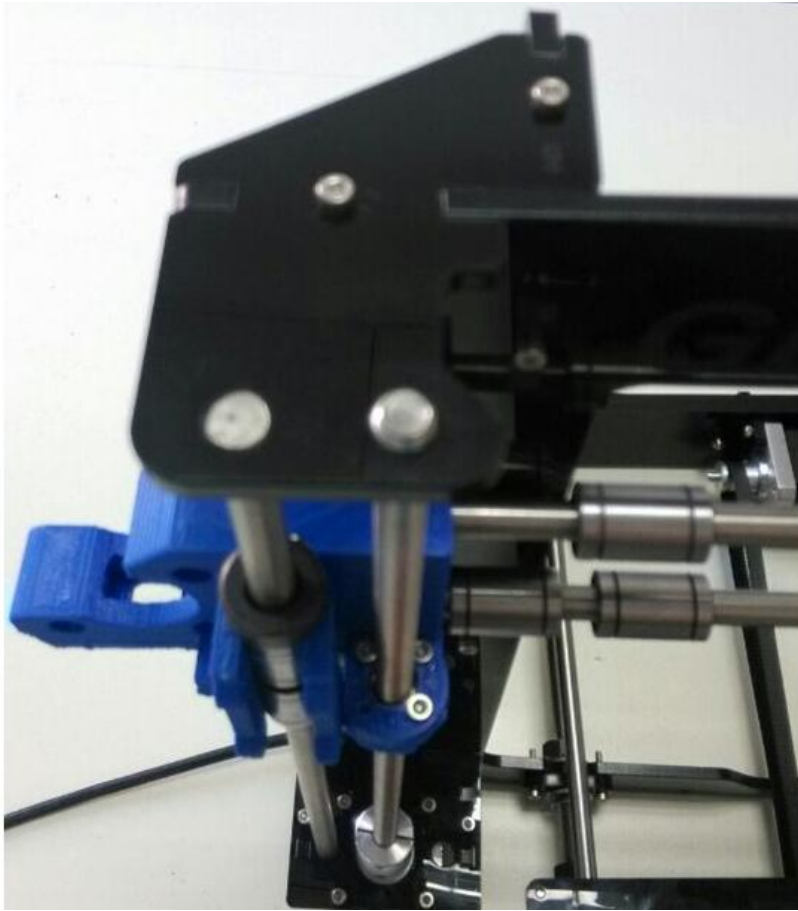

6 Mount the extruder on the X axis

step1. Thread the zip-tie through the extruder bracket.



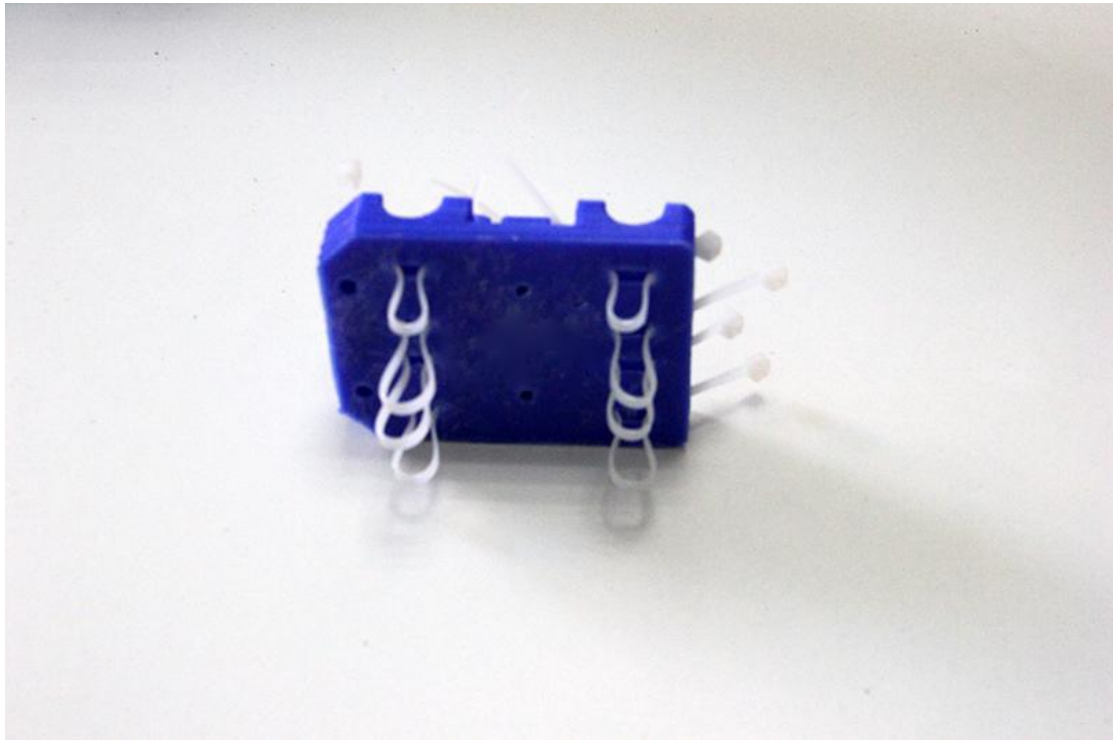

Step2. Mount the extruder bracket on the smooth rod and insert the two bearings into the bracket. Tie up the Y belt then.

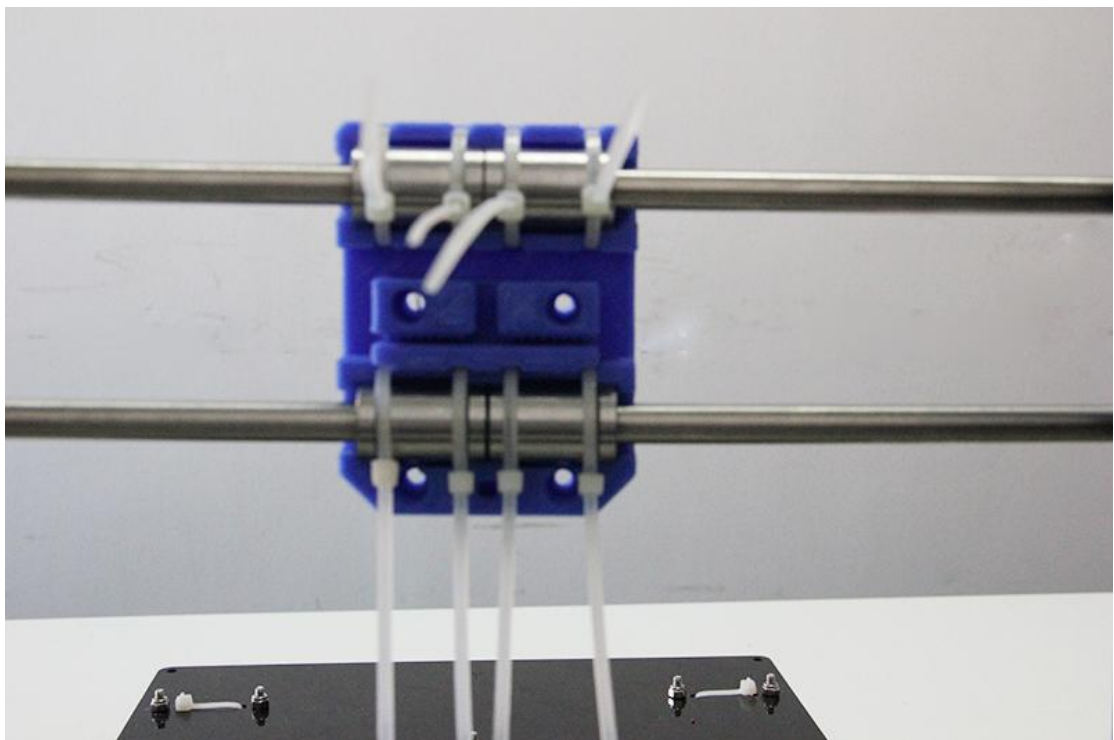

Step3.
Amount the extruder support.

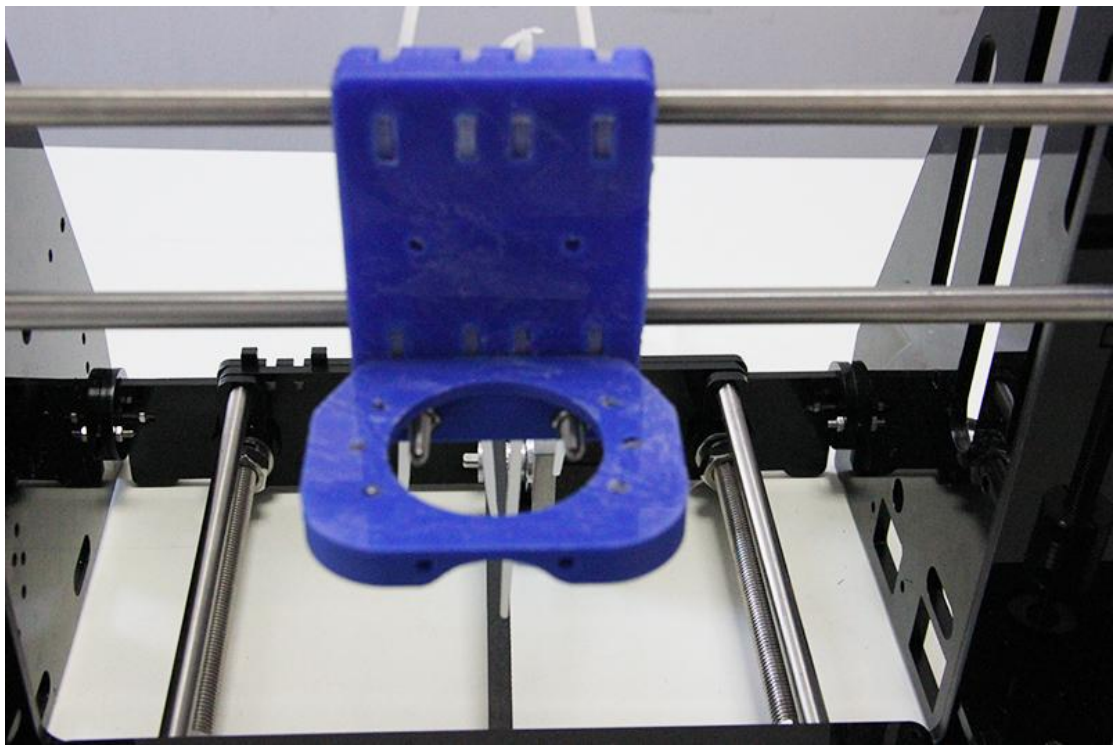

Step4. Mount the extruder

This is the fully assembled MK8 extruder.



Take the nozzle part and the bolt out.



Mount the aluminum plate under the extruder.

Required parts	Part ID
MK8 assemble board	65

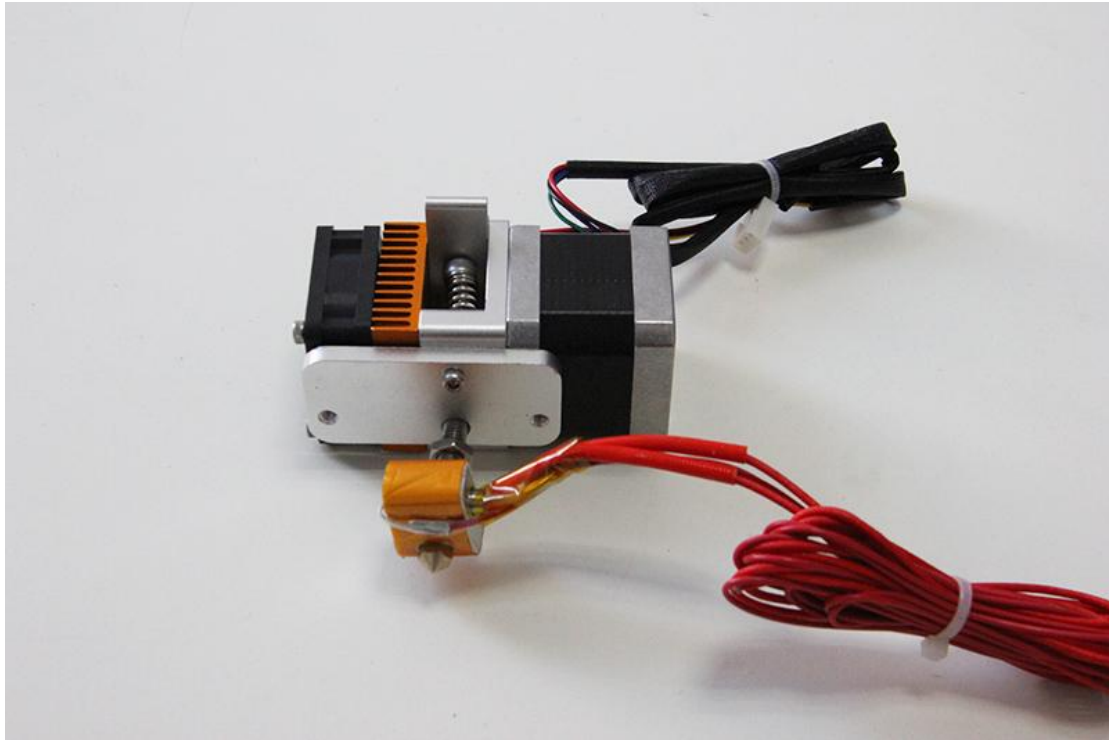

Fix the assembled extruder on the blue part. Pay attention to the direction of the motor and the fan.

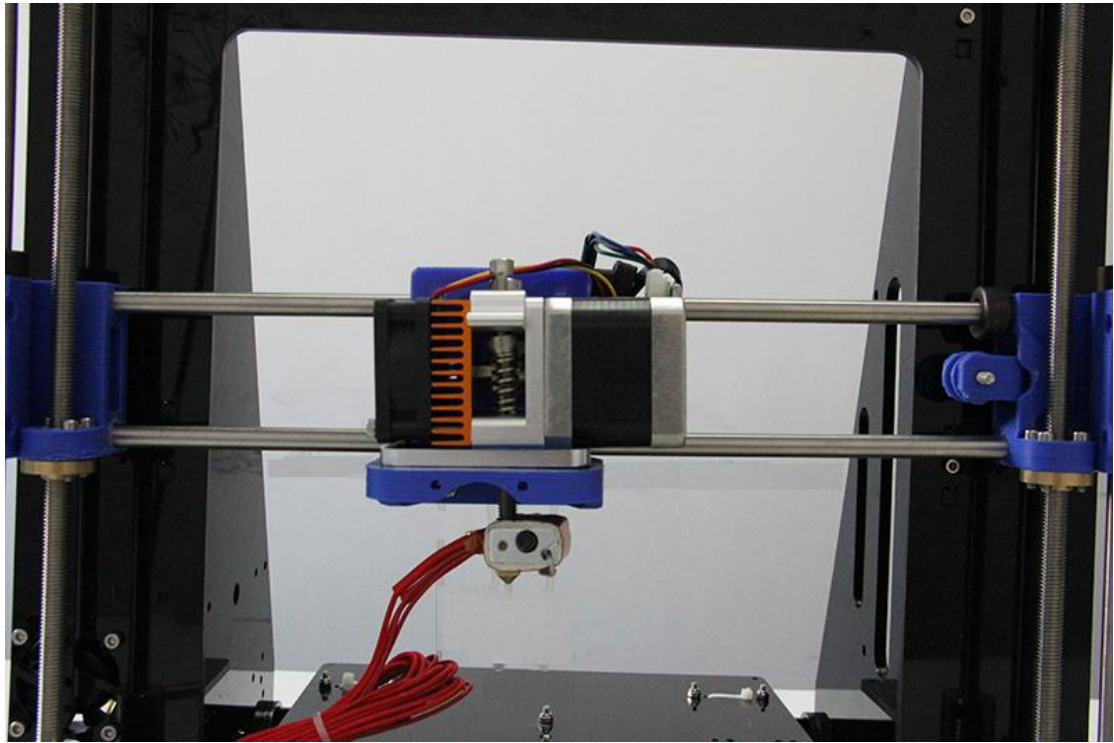

Pay attention to the exit of the red wire, it will affect the final wiring steps.

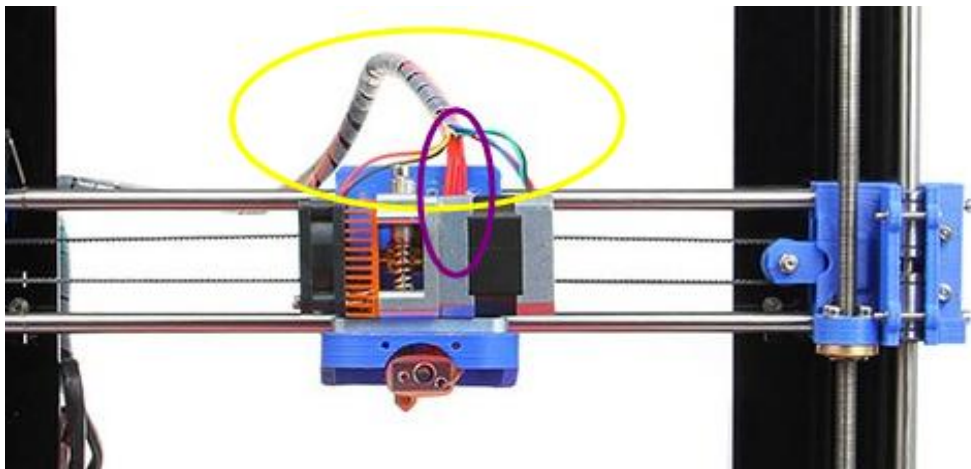

Mount the X-axis motor

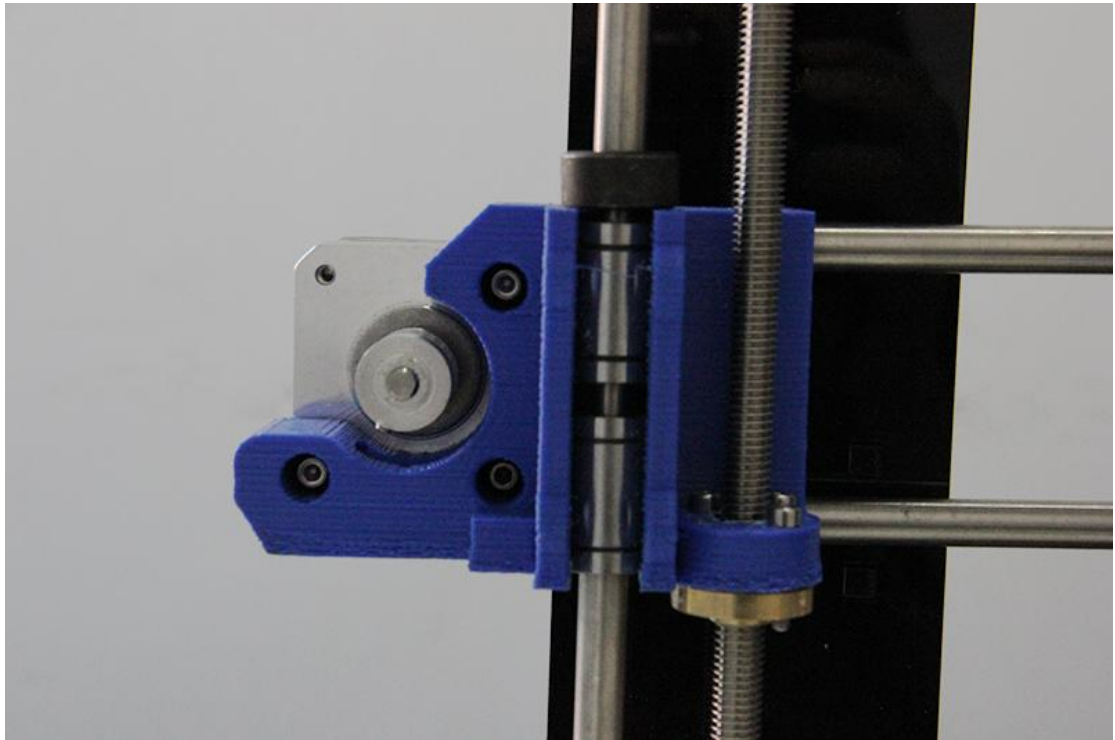
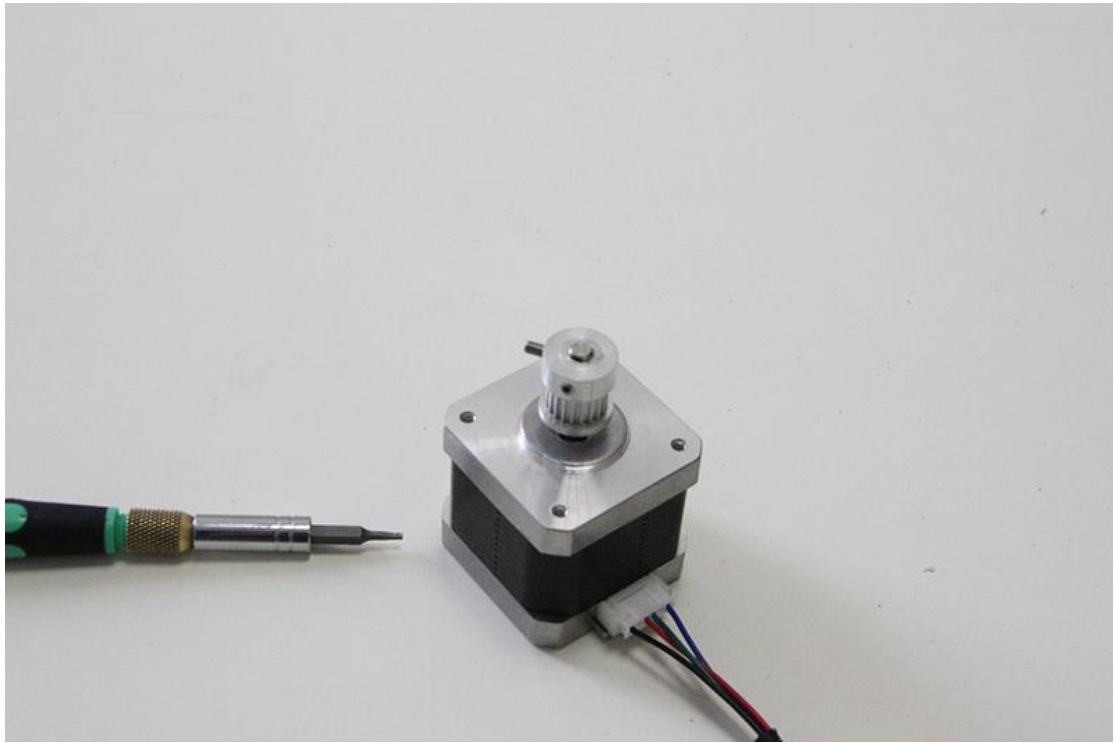

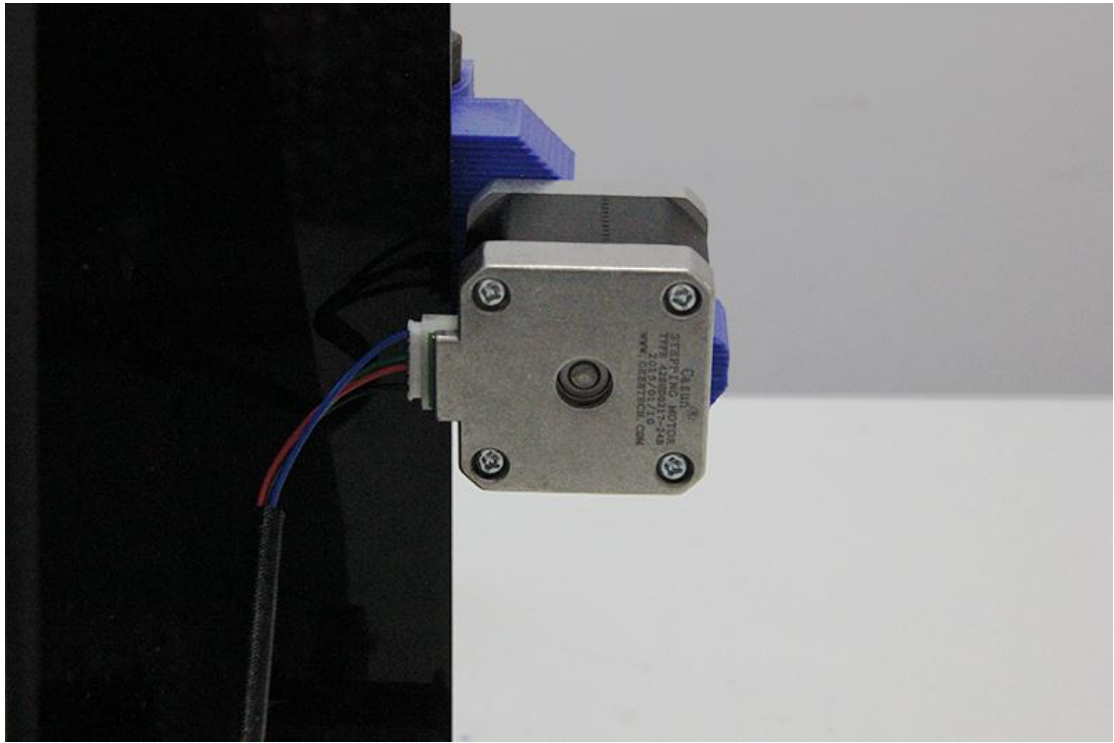

8.3 assemble the belt.

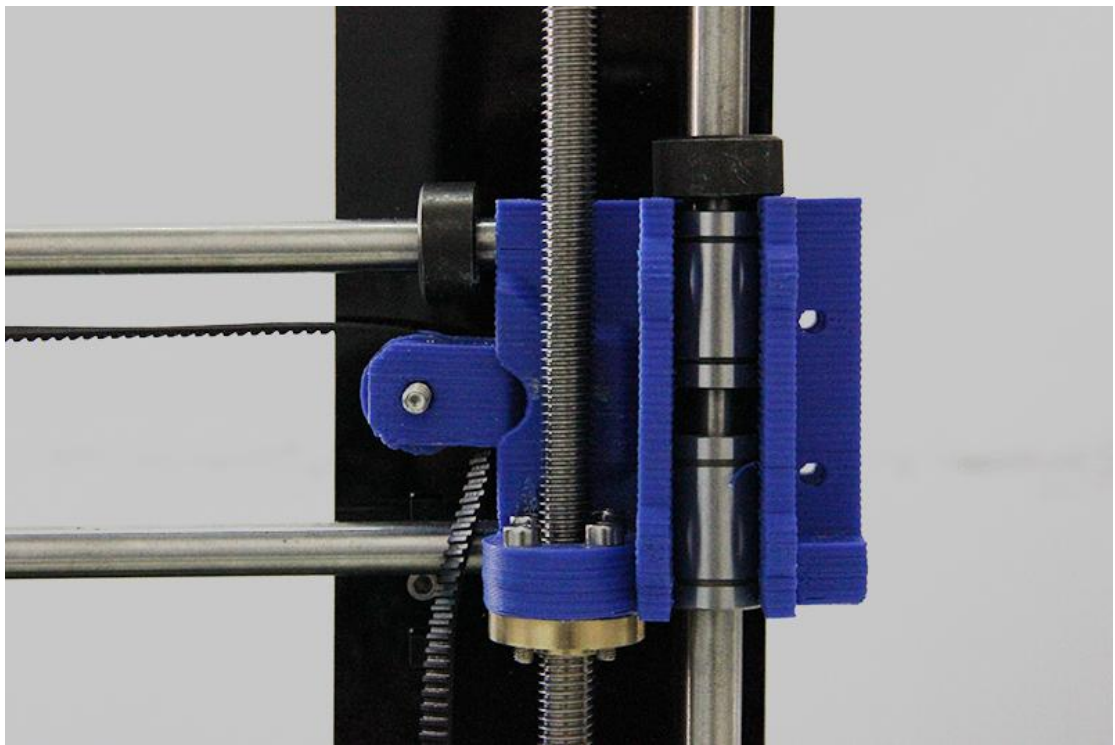
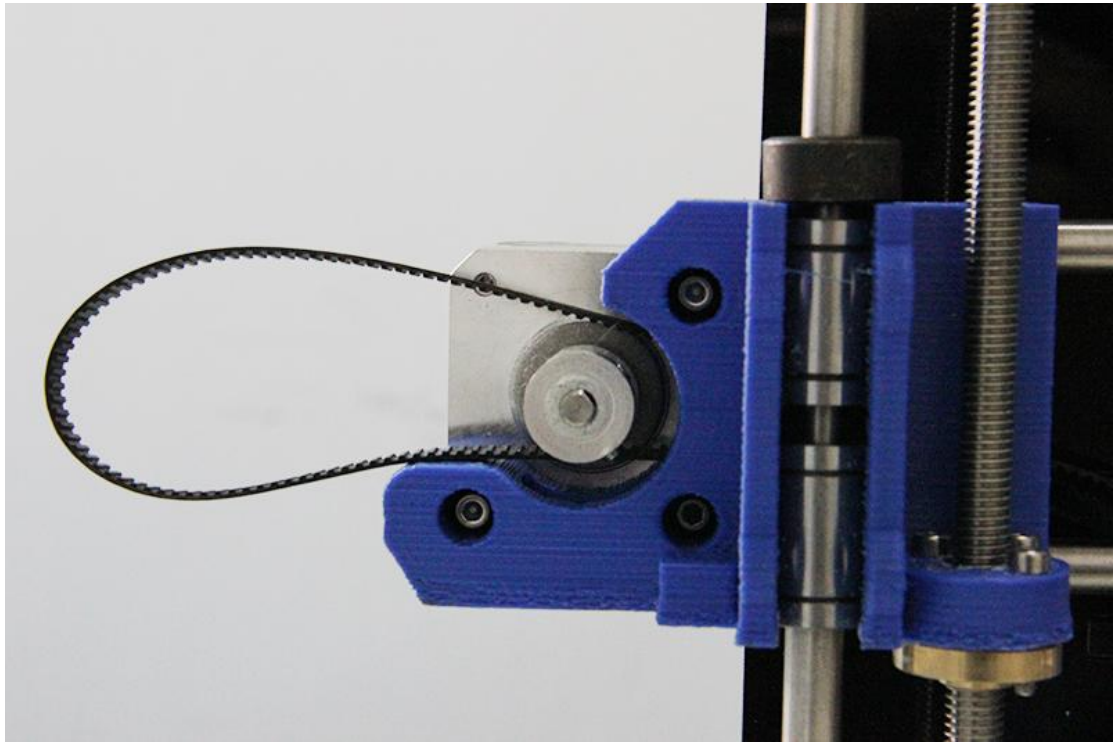

Pay attention to the tooth mesh of the belt and the part in red circle.

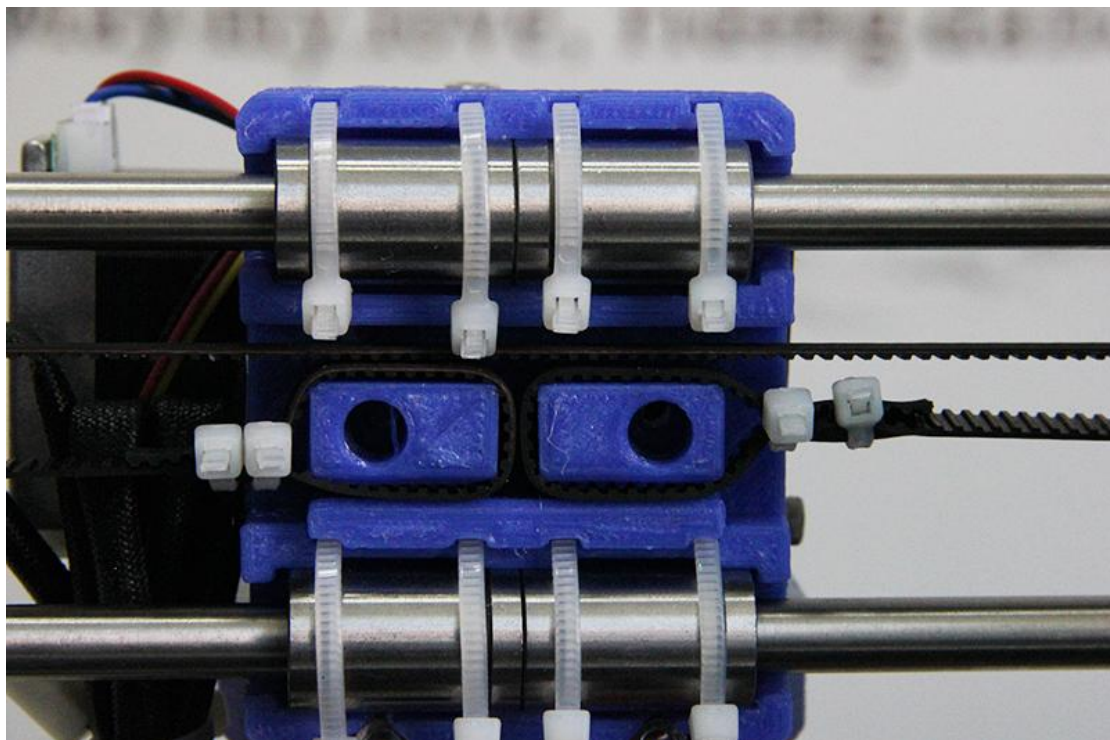
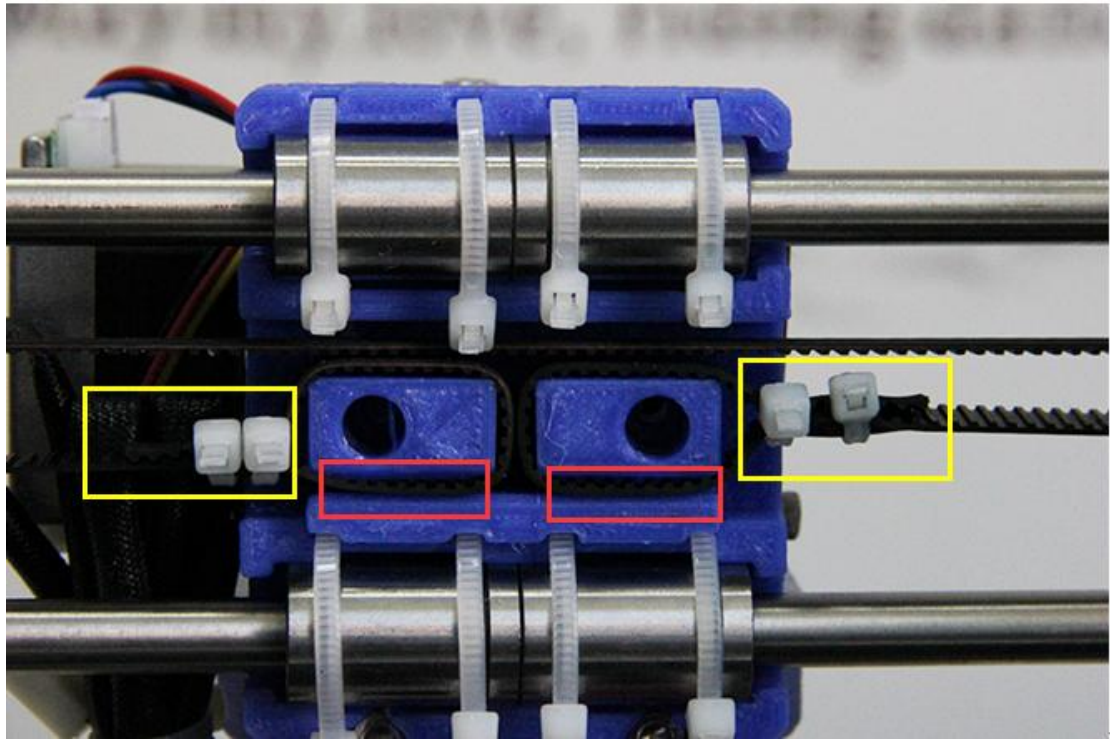

7 Mount the end stops.

End stop of X-axis

Required parts	Part ID
X-axis bracket of end stop	P10
End stop	26

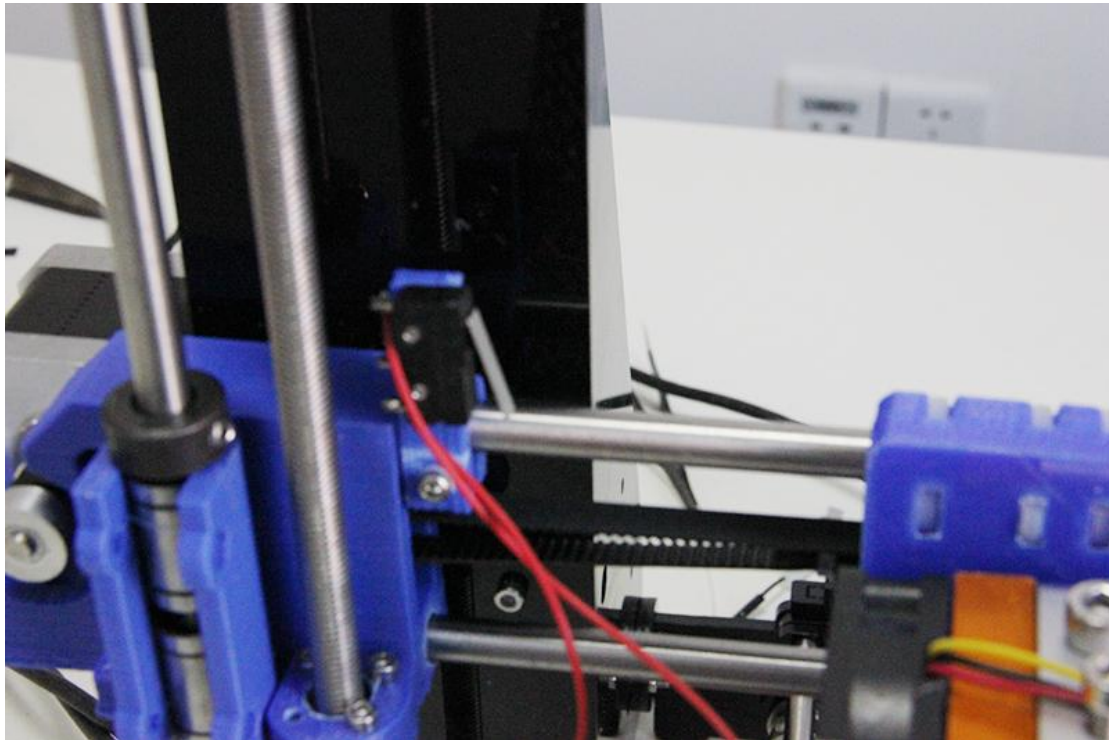

End stop of Y-axis

Required parts	Part ID
End stop	37
Z-axis bracket of end stop	P5

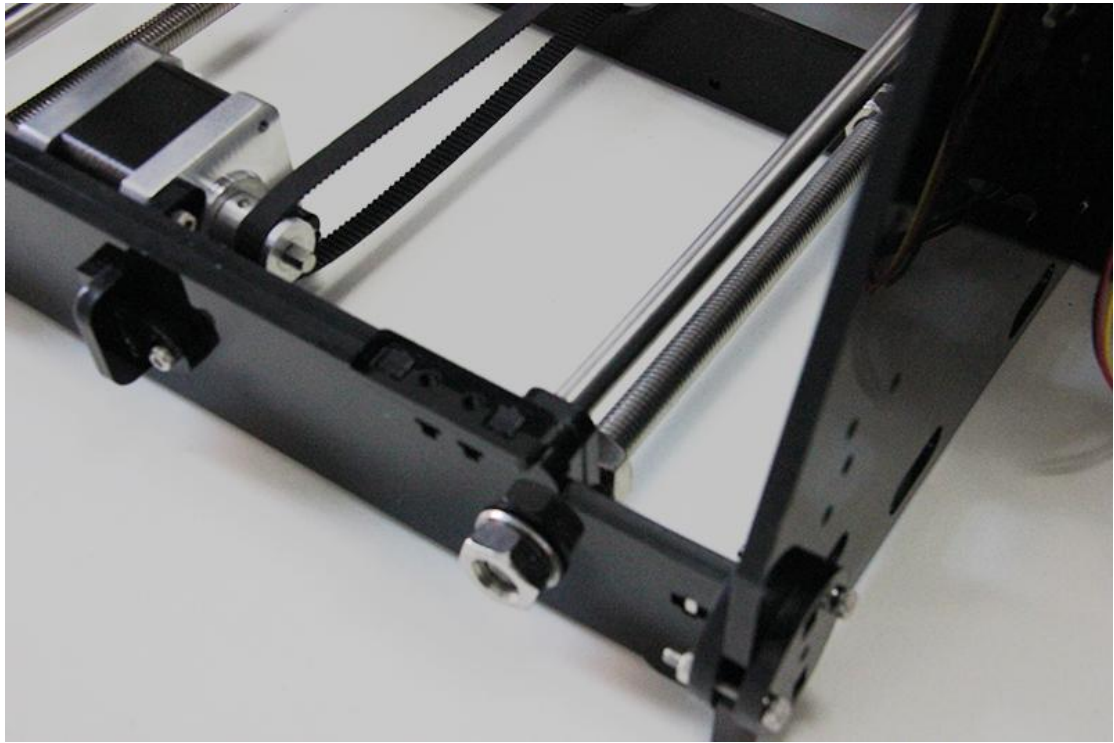

Note the direction of the switch.

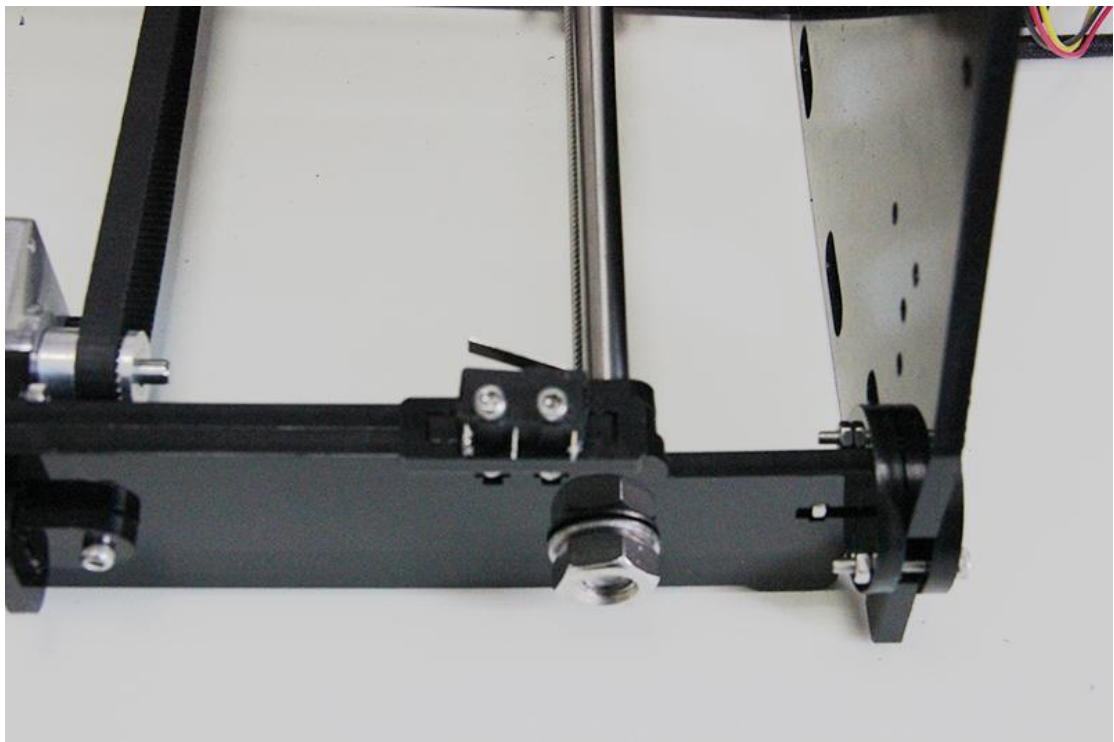

End stop of Z-axis

Required parts	Part ID
End stop	38
Z-axis bracket of end stop	P5

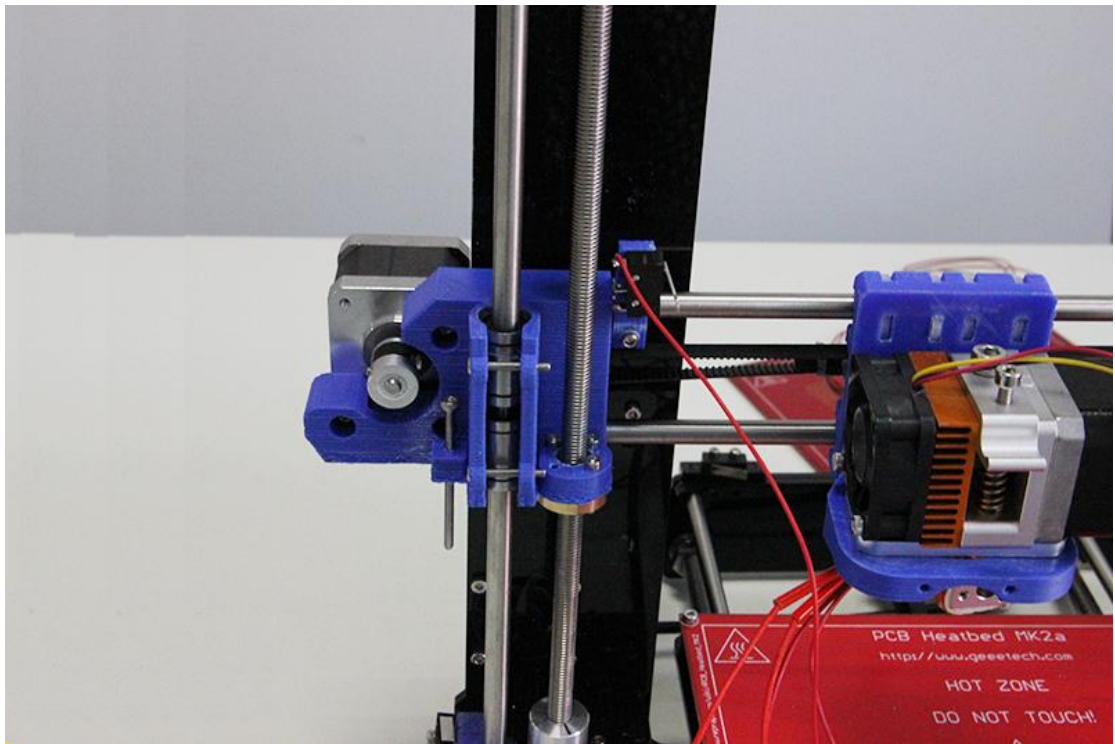
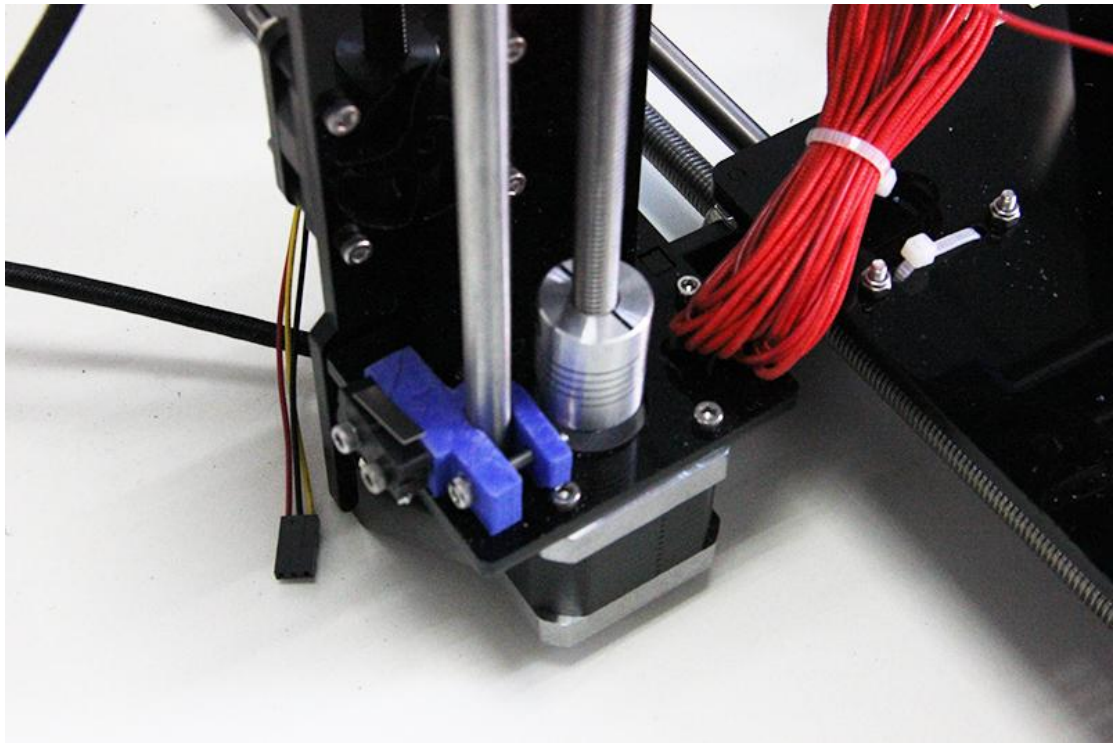

8 Mount the LCD panel frame.



9 Mount the filament spool.

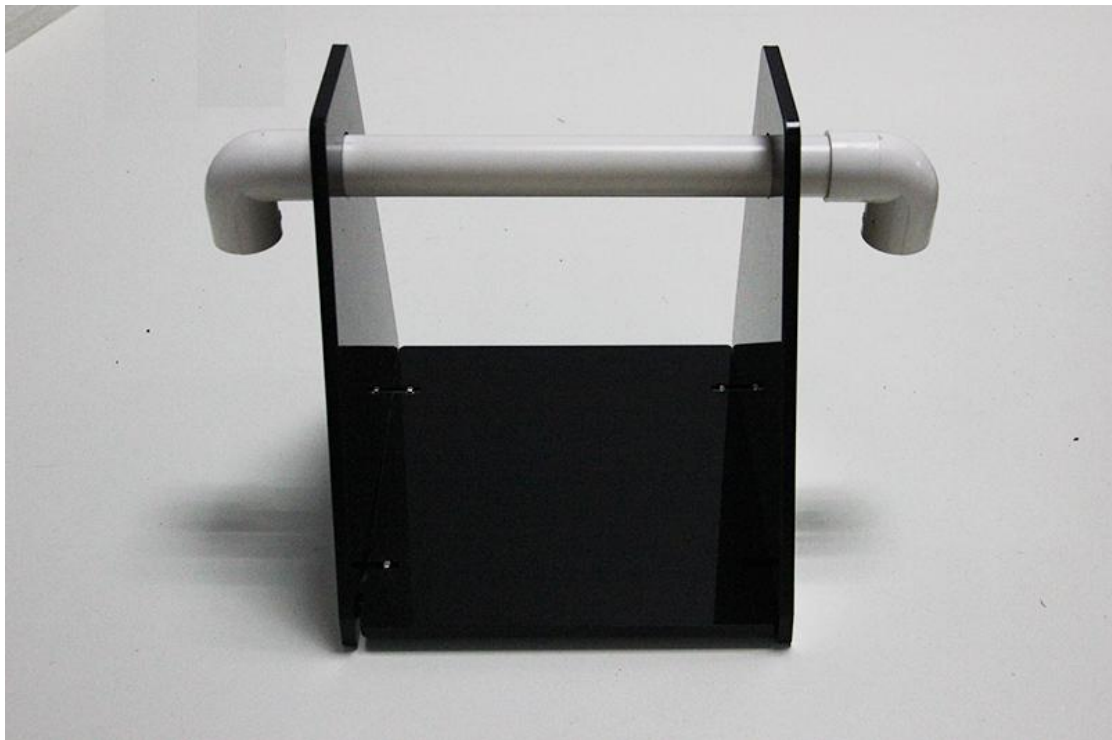

So far, the framework of the 3D printer is almost finished.

10 mount the control board on the left side panel

13.1 Ramps 1.4 + Mega 2560 + A4988

Stack the Ramps 1.4 on the Mega 2560 and plug the 5 A4988 on the Ramps 1.4.

13.2 Sanguinololu

Plug the 5 A4988 on Sanguinololu

11 Mount the PSU on the right side panel

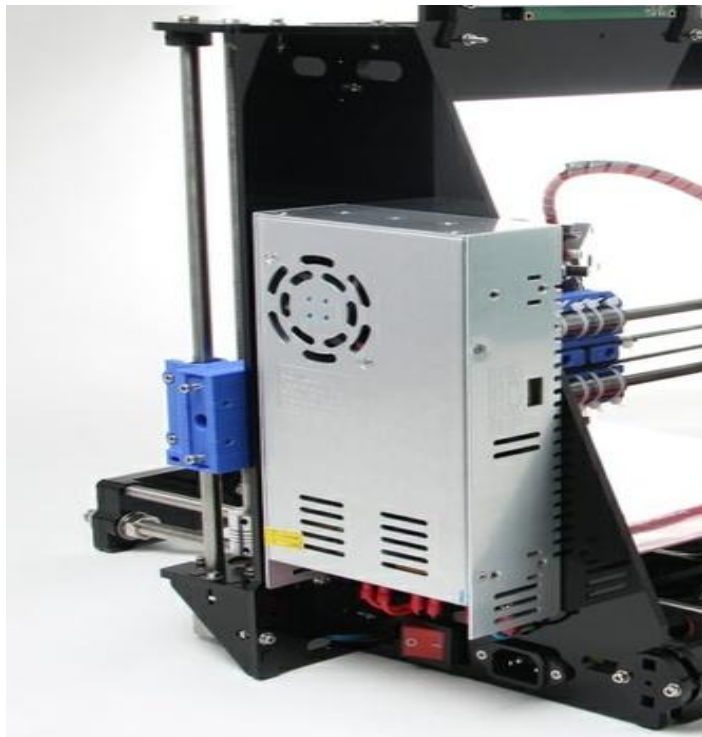

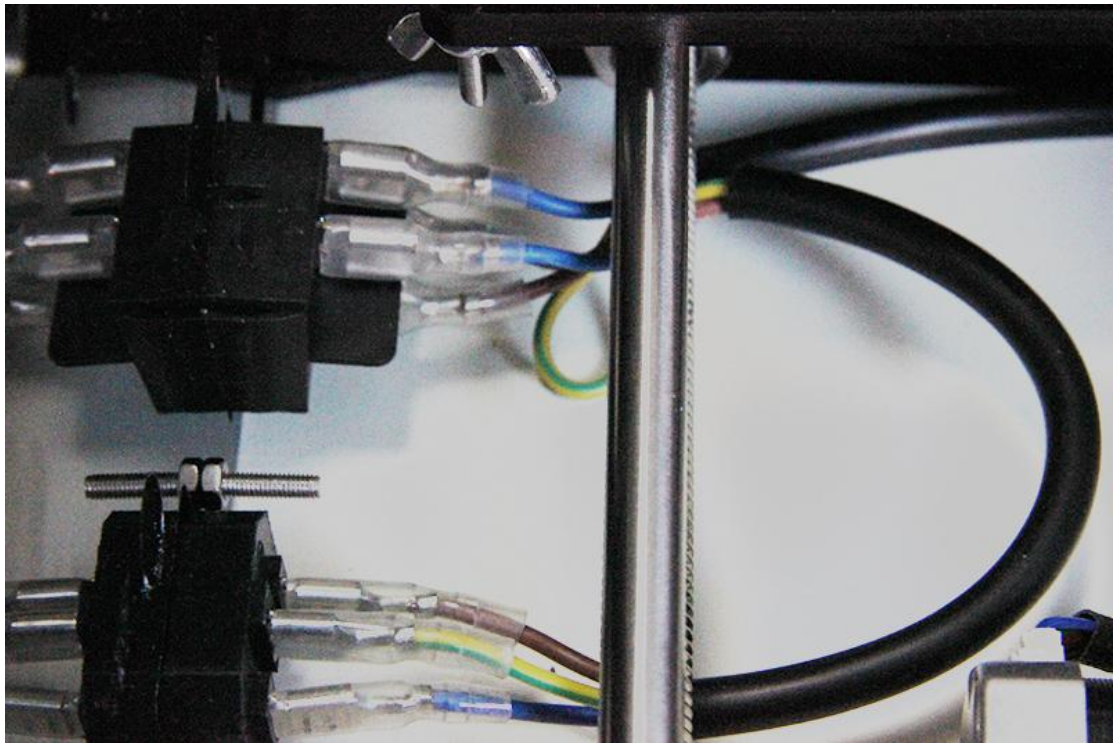

12 wiring

12.1 PSU wiring

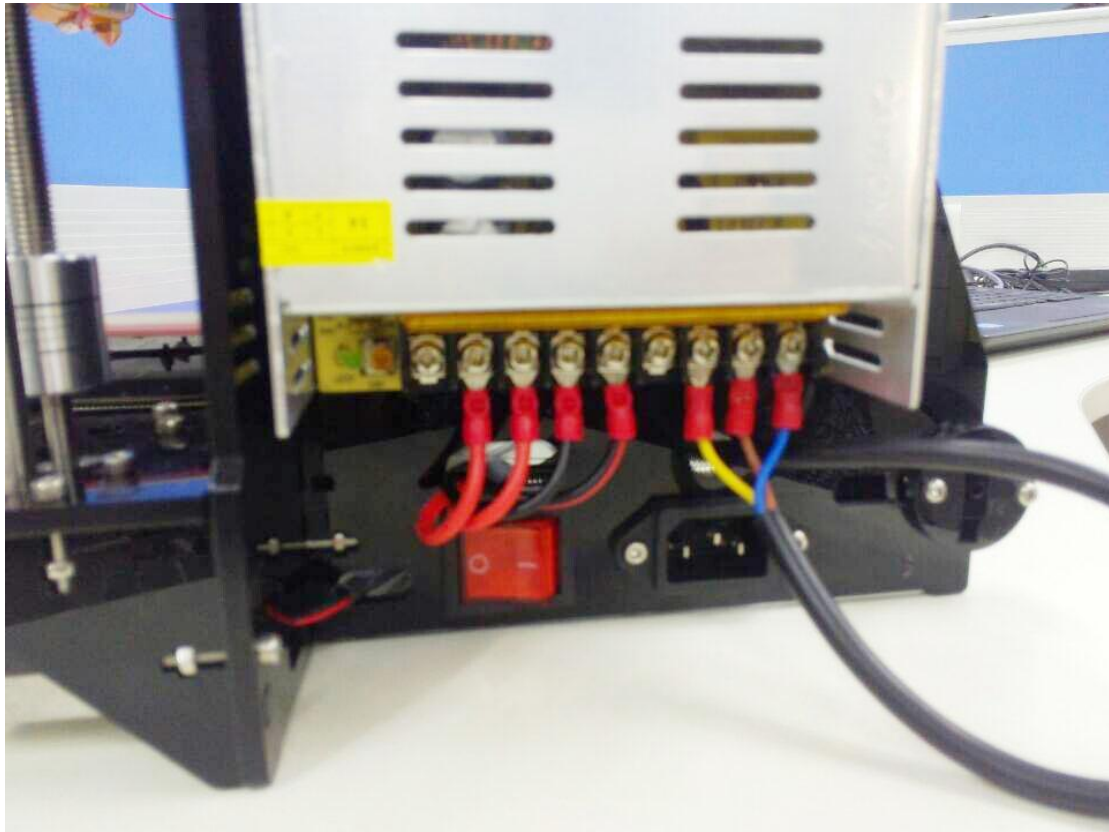

12.2 control board wiring

- 1) The referring wiring schematic diagram of Ramps 1.4

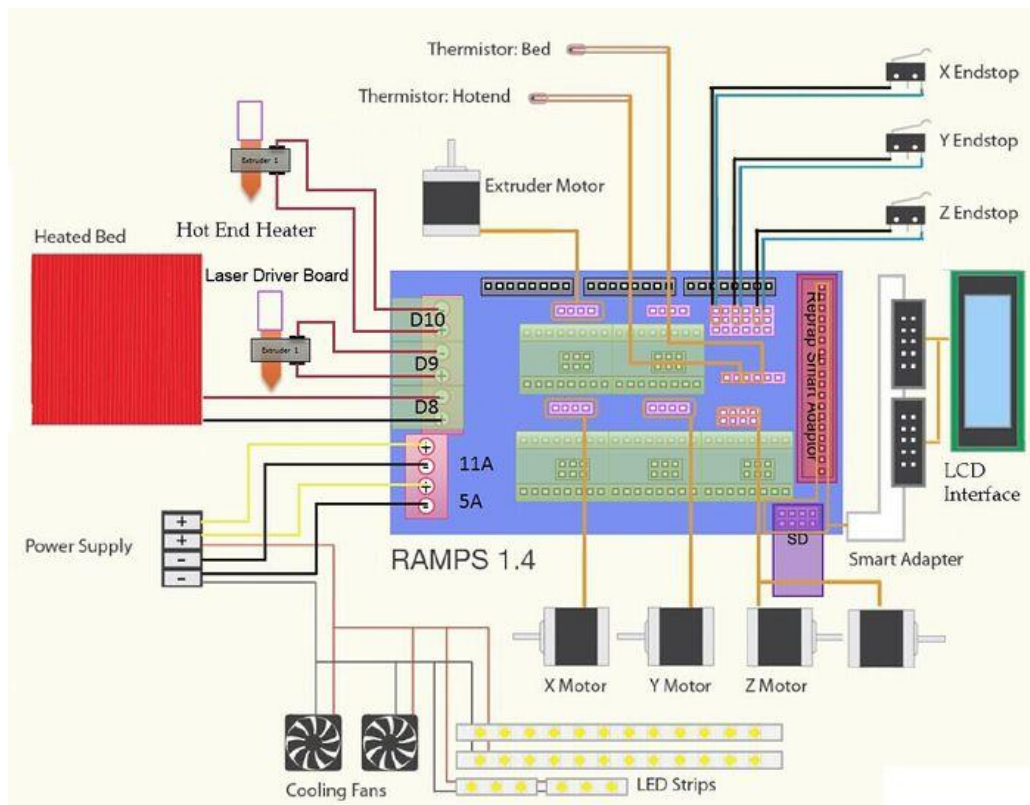

2) The referring wiring schematic diagram of Sanguinololu

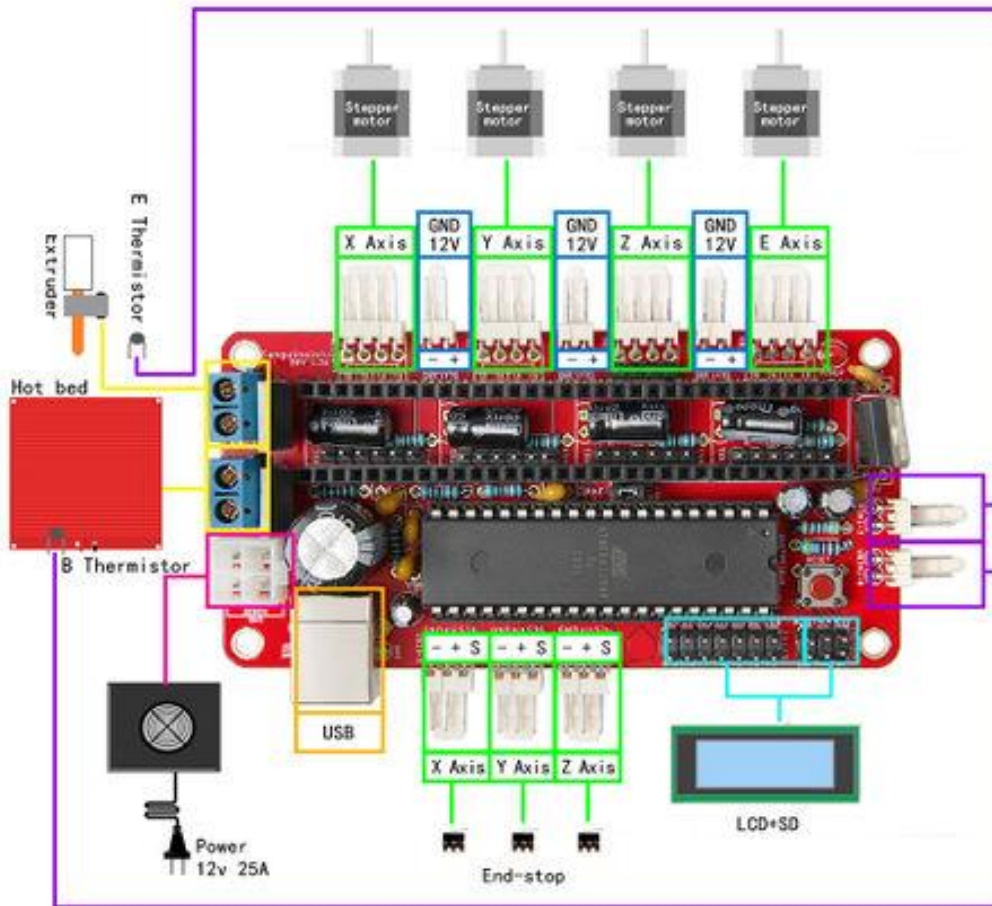

All the wires can be tied together under the printer, but you should make sure they don't touch the belt.

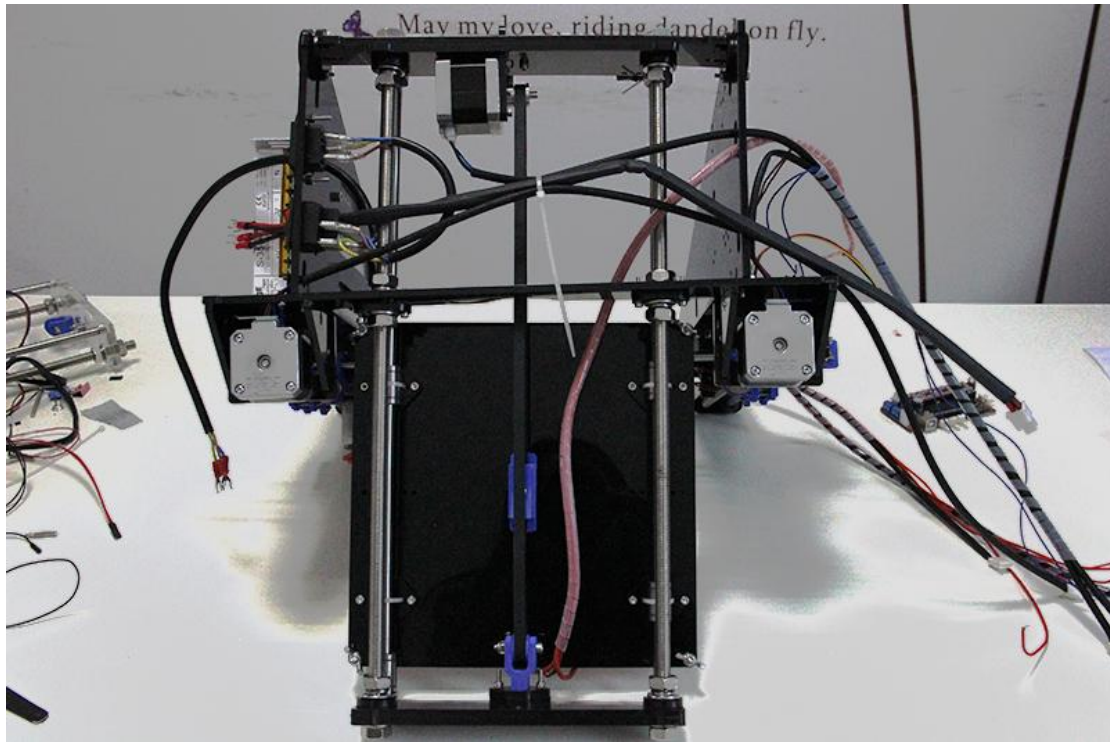

The whole printer assembly work is already done.

Next is the testing and debugging.